

CELLULAR MOBILE COMMUNICATION

UNIT I

INTRODUCTION TO WIRELESS MOBILE COMMUNICATION

Introduction:

- ❖ In 1897, Guglielmo Marconi first demonstrated radio's ability to provide continuous contact with ships sailing the English channel.

- ❖ During the past 10 years, fueled by
 - ❖ Digital and RF circuit fabrication improvements
 - ❖ New VLSI technologies
 - ❖ Other miniaturization technologies
(e.g., passive components)
 - ❖ The mobile communications industry has grown by orders of magnitude.

- ❖ The trends will continue at an even greater pace during the next decade.

Evolution of Mobile Radio Communications

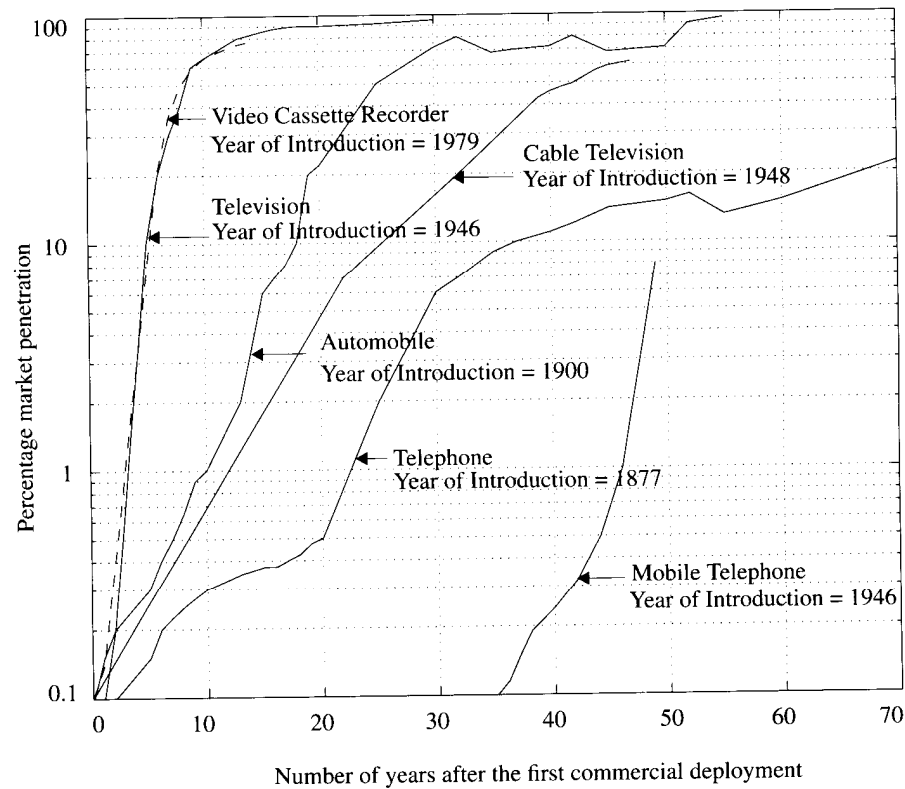
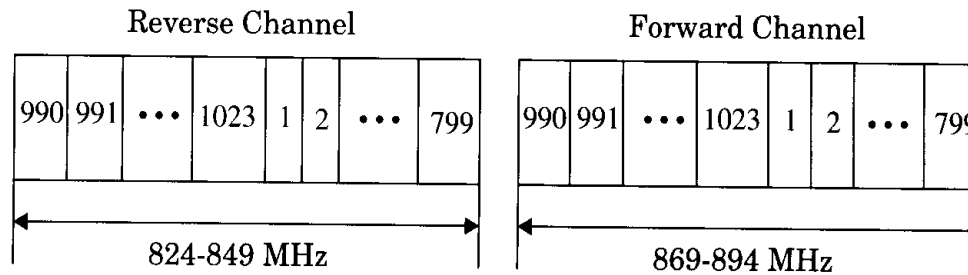

Figure 1.1
Figure illustrating the growth of mobile telephony as compared to other popular inventions of this century.

- ❖ In 1934, AM mobile communication systems for municipal police radio systems.
 - ❖ Vehicle ignition noise was a major problem.
- ❖ In 1946, FM mobile communications for the first public mobile telephone service
 - ❖ Each system used a single, high-powered transmitter and large tower to cover distances of over 50 km.
 - ❖ Used 120 kHz of RF bandwidth in a half-duplex mode. (push-to-talk release-to-listen systems.)
 - ❖ Large RF bandwidth was largely due to the technology difficulty (in mass-producing tight RF filter and low-noise, front-end receiver amplifiers.)
- ❖ In 1950, the channel bandwidth was cut in half to 60kHz due to improved technology.
- ❖ By the mid 1960s, the channel bandwidth again was cut to 30 kHz.
- ❖ Thus, from WWII to the mid 1960s, the spectrum efficiency was improved only a factor of 4 due to the technology advancements.

- ❖ Also in 1950s and 1960s, automatic channel trunking was introduced in IMTS(Improved Mobile Telephone Service.)
 - ❖ offering full duplex, auto-dial, auto-trunking
 - ❖ became saturated quickly
 - ❖ By 1976, has only twelve channels and could only serve 543 customers in New York City of 10 millions populations.
- ❖ Cellular radiotelephone
 - ❖ Developed in 1960s by Bell Lab and others
 - ❖ The basic idea is to reuse the channel frequency at a sufficient distance to increase the spectrum efficiency.
 - ❖ But the technology was not available to implement until the late 1970s. (mainly the microprocessor and DSP technologies.)

- ❖ In 1983, AMPS (Advanced Mobile Phone System, IS-41) deployed by Ameritech in Chicago.
 - ❖ 40 MHz spectrum in 800 MHz band
 - ❖ 666 channels (+ 166 channels), per Fig 1.2.
 - ❖ Each duplex channel occupies > 60 kHz (30+30) FDMA to maximize capacity.
 - ❖ Two cellular providers in each market.



	Channel Number	Center Frequency (MHz)
Reverse Channel	$1 \leq N \leq 799$	$0.030N + 825.0$
	$990 \leq N \leq 1023$	$0.030(N - 1023) + 825.0$
Forward Channel	$1 \leq N \leq 799$	$0.030N + 870.0$
	$990 \leq N \leq 1023$	$0.030(N - 1023) + 870.0$

(Channels 800 - 989 are unused)

Figure 1.2

Frequency spectrum allocation for the U.S. cellular radio service. Identically labeled channels in the two bands form a forward and reverse channel pair used for duplex communication between the base station and mobile. Note that the forward and reverse channels in each pair are separated by 45 MHz.

- ❖ In late 1991, U.S. Digital Cellular (USDC, IS-54) was introduced.
 - ❖ to replace AMPS analog channels
 - ❖ 3 times of capacity due to the use of digital modulation ($\frac{\pi}{4}$ DQPSK), speech coding, and TDMA technologies.
 - ❖ could further increase up to 6 times of capacity given the advancements of DSP and speech coding technologies.
- ❖ In mid 1990s, Code Division Multiple Access (CDMA, IS-95) was introduced by Qualcomm.
 - ❖ based on spread spectrum technology.
 - ❖ supports 6-20 times of users in 1.25 MHz shared by all the channels.
 - ❖ each associated with a unique code sequence.
 - ❖ operate at much smaller SNR.(FdB)

Table 1.1 Major Mobile Radio Standards in North America

Standard	Type	Year of Introduction	Multiple Access	Frequency Band	Modulation	Channel Bandwidth
AMPS	Cellular	1983	FDMA	824-894 MHz	FM	30 kHz
NAMPS	Cellular	1992	FDMA	824-894 MHz	FM	10 kHz
USDC	Cellular	1991	TDMA	824-894 MHz	$\pi/4$ -DQPSK	30 kHz
CDPD	Cellular	1993	FH/ Packet	824-894 MHz	GMSK	30 kHz
IS-95	Cellular/ PCS	1993	CDMA	824-894 MHz 1.8-2.0 GHz	QPSK/ BPSK	1.25 MHz
GSC	Paging	1970s	Simplex	Several	FSK	12.5 kHz
POCSAG	Paging	1970s	Simplex	Several	FSK	12.5 kHz
FLEX	Paging	1993	Simplex	Several	4-FSK	15 kHz
DCS-1900 (GSM)	PCS	1994	TDMA	1.85-1.99 GHz	GMSK	200 kHz
PACS	Cordless/ PCS	1994	TDMA/ FDMA	1.85-1.99 GHz	$\pi/4$ - DQPSK	300 kHz
MIRS	SMR/PCS	1994	TDMA	Several	16-QAM	25 kHz
iDen	SMR/PCS	1995	TDMA	Several	16-QAM	25 kHz

users. In the U.S., the PACS standard, developed by Bellcore and Motorola, is likely to be used inside office buildings as a wireless voice and data telephone system or radio local loop. The Personal Handyphone System (PHS) standard supports indoor and local loop applications in Japan. Local loop concepts are explained in Chapter 10.

The world's first cellular system was implemented by the Nippon Telephone and Telegraph company (NTT) in Japan. The system, deployed in 1979, uses 600 FM duplex channels (25 kHz for each one-way link) in the 800 MHz band. In Europe, the Nordic Mobile Telephone system

Table 1.2 Major Mobile Radio Standards in Europe

Standard	Type	Year of Introduction	Multiple Access	Frequency Band	Modulation	Channel Bandwidth
E-TACS	Cellular	1985	FDMA	900 MHz	FM	25 kHz
NMT-450	Cellular	1981	FDMA	450-470 MHz	FM	25 kHz
NMT-900	Cellular	1986	FDMA	890-960 MHz	FM	12.5 kHz
GSM	Cellular /PCS	1990	TDMA	890-960 MHz	GMSK	200 kHz
C-450	Cellular	1985	FDMA	450-465 MHz	FM	20 kHz/ 10 kHz
ERMES	Paging	1993	FDMA	Several	4-FSK	25 kHz
CT2	Cordless	1989	FDMA	864-868 MHz	GFSK	100 kHz
DECT	Cordless	1993	TDMA	1880-1900 MHz	GFSK	1.728 MHz
DCS-1800	Cordless /PCS	1993	TDMA	1710-1880 MHz	GMSK	200 kHz

Table 1.3 Major Mobile Radio Standards in Japan

Standard	Type	Year of Introduction	Multiple Access	Frequency Band	Modulation	Channel Bandwidth
JTACS	Cellular	1988	FDMA	860-925 MHz	FM	25 kHz
PDC	Cellular	1993	TDMA	810-1501 MHz	$\pi/4$ -DQPSK	25 kHz
NTT	Cellular	1979	FDMA	400/800 MHz	FM	25 kHz
NTACS	Cellular	1993	FDMA	843-925 MHz	FM	12.5 kHz
NTT	Paging	1979	FDMA	280 MHz	FSK	12.5 kHz
NEC	Paging	1979	FDMA	Several	FSK	10 kHz
PHS	Cordless	1993	TDMA	1895-1907 MHz	$\pi/4$ -DQPSK	300 kHz

Examples of Mobile Radio Systems

Table 1.4 Wireless Communications System Definitions

Base Station	A fixed station in a mobile radio system used for radio communication with mobile stations. Base stations are located at the center or on the edge of a coverage region and consist of radio channels and transmitter and receiver antennas mounted on a tower.
Control Channel	Radio channels used for transmission of call setup, call request, call initiation, and other beacon or control purposes.
Forward Channel	Radio channel used for transmission of information from the base station to the mobile.
Full Duplex Systems	Communication systems which allow simultaneous two-way communication. Transmission and reception is typically on two different channels (FDD) although new cordless/PCS systems are using TDD.
Half Duplex Systems	Communication systems which allow two-way communication by using the same radio channel for both transmission and reception. At any given time, the user can only either transmit or receive information.
Handoff	The process of transferring a mobile station from one channel or base station to another.
Mobile Station	A station in the cellular radio service intended for use while in motion at unspecified locations. Mobile stations may be hand-held personal units (portables) or installed in vehicles (mobiles).
Mobile Switching Center	Switching center which coordinates the routing of calls in a large service area. In a cellular radio system, the MSC connects the cellular base stations and the mobiles to the PSTN. An MSC is also called a mobile telephone switching office (MTSO).
Page	A brief message which is broadcast over the entire service area, usually in a simulcast fashion by many base stations at the same time.
Reverse Channel	Radio channel used for transmission of information from the mobile to base station.
Roamer	A mobile station which operates in a service area (market) other than that from which service has been subscribed.
Simplex Systems	Communication systems which provide only one-way communication.
Subscriber	A user who pays subscription charges for using a mobile communications system.
Transceiver	A device capable of simultaneously transmitting and receiving radio signals.

- ❖ In FDD,
 - ❖ A device, called a duplexer, is used inside the subscriber unit to enable the same antenna to be used for simultaneous transmission and reception.
 - ❖ To facilitate FDD, it is necessary to separate the XMIT and RCVD frequencies by about 5% of the nominal RF frequency, so that the duplexer can provide sufficient isolation while being inexpensively manufactured.
- ❖ In TDD,
 - ❖ Only possible with digital transmission format and digital modulation.
 - ❖ Very sensitive to timing. Consequently, only used for indoor or small area wireless applications.

Paging Systems

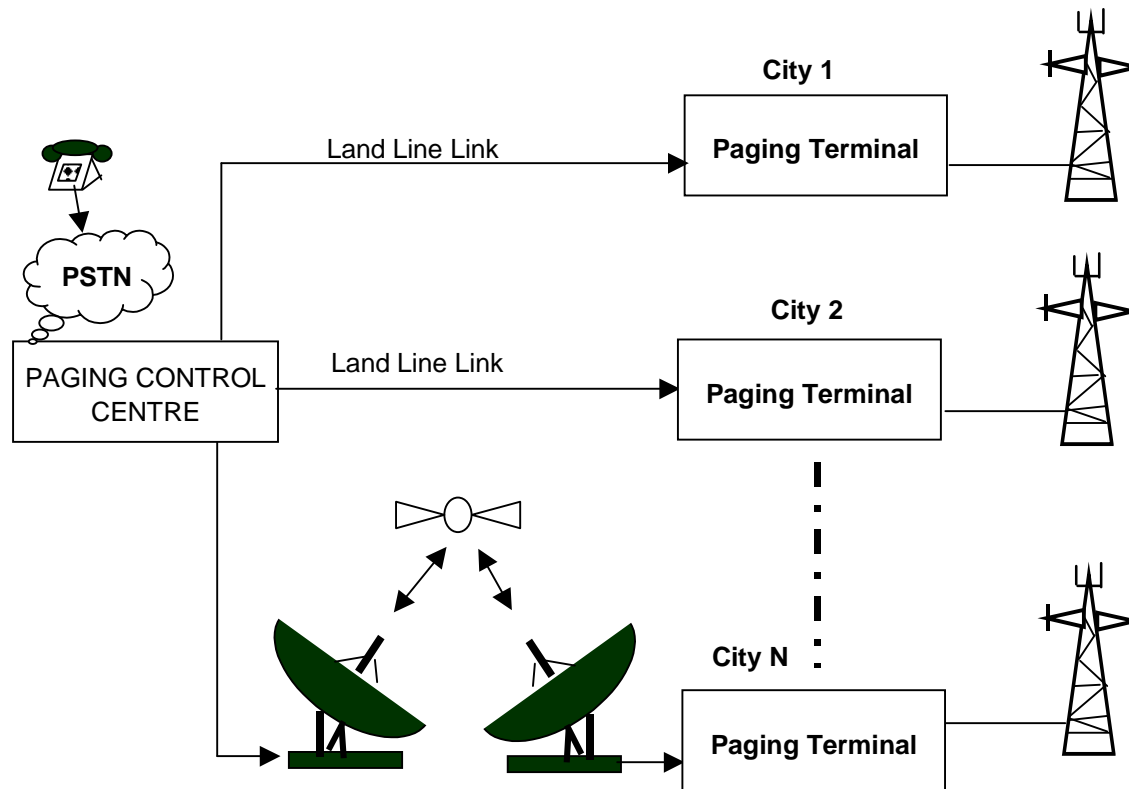

- ❖ Paging receivers are simple and inexpensive, but the transmission system required is quite sophisticated. (simulcasting)
- ❖ designed to provide ultra-reliable coverage, even inside buildings
- ❖ Buildings can attenuate radio signals by 20 or 30 dB, making the choice of base station locations difficult for the paging companies.
- ❖ Small RF bandwidths are used to maximize the signal-to-noise ratio at each paging receiver, so low data rates (6400 bps or less) are used.

Wireless Local Loop

- ❖ In the telephone networks, the circuit between the subscriber's equipment (e.g. telephone set) and the local exchange is called the subscriber loop or local loop.
- ❖ Copper wire has been used as the medium for local loop to provide voice and voice-band data services.
- ❖ Since 1980s, the demand for communications services has increased explosively. There has been a great need for the basic telephone service, i.e. the plain old telephone service (POTS) in developing countries.
- ❖ Wireless local loop provides two-ways a telephone system.....
- ❖ Wireless local loop includes cordless access system, proprietary fixed radio access system and fixed cellular system. It is also known as fixed radio wireless. This can be in an office or home.
- ❖ Broadband Wireless Access (BWA), Radio In The Loop (RITL), Fixed-Radio Access (FRA) and Fixed Wireless Access (FWA).

Cordless Telephone System

- ❖ To Connect a Fixed Base Station to a Portable Cordless Handset
- ❖ Early Systems (1980s) have very limited range of few tens of meters [within a House Premises]
- ❖ Modern Systems [PACS, DECT, PHS, PCS] can provide a limited range & mobility within Urban Centers

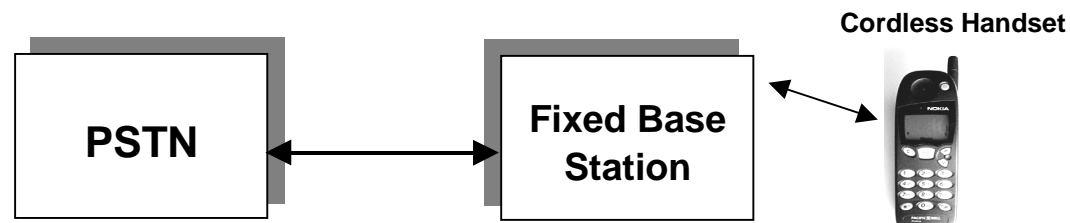

- ❖ Limitations of Simple Mobile Radio Systems
- ❖ The Cellular Approach
 - ❖ Divides the Entire Service Area into Several Small Cells
 - ❖ Reuse the Frequency
- ❖ Basic Components of a Cellular Telephone System
 - ❖ **Cellular Mobile Phone:** A light-weight hand-held set which is an outcome of the marriage of Graham Bell's Plain Old Telephone Technology [1876] and Marconi's Radio Technology [1894] [although a very late delivery but very cute]
 - ❖ **Base Station:** A Low Power Transmitter, other Radio Equipment [Transceivers] plus a small Tower
 - ❖ **Mobile Switching Center [MSC] /Mobile Telephone Switching Office[MTSO]**
 - ❖ An Interface between Base Stations and the PSTN
 - ❖ Controls all the Base Stations in the Region and Processes User ID and other Call Parameters
 - ❖ A typical MSC can handle up to 100,000 Mobiles, and 5000 Simultaneous Calls
 - ❖ Handles Handoff Requests, Call Initiation Requests, and all Billing & System Maintenance Functions

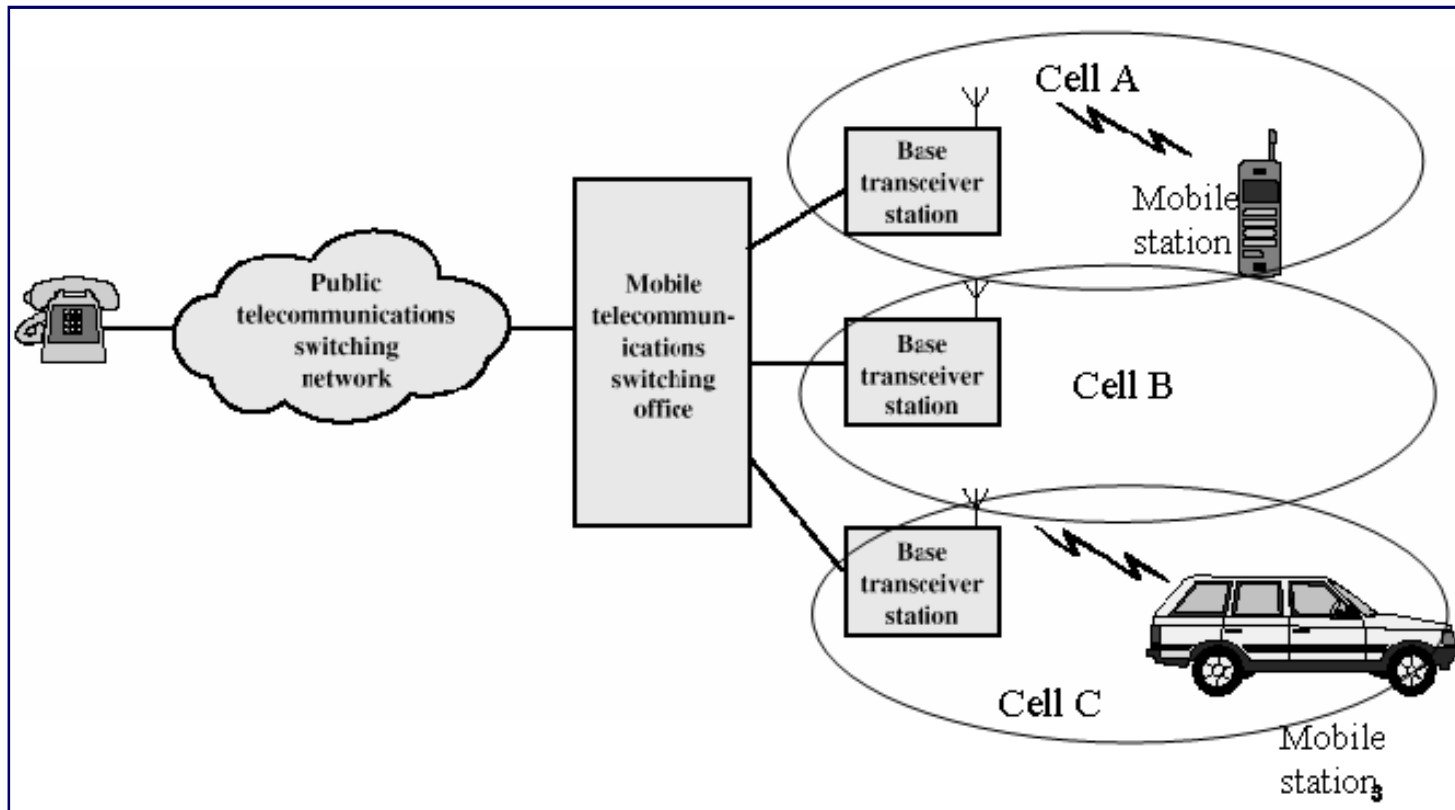

❖ The Cellular Concept

- ❖ RF spectrum is a valuable and scarce commodity
- ❖ RF signals attenuate over distance
- ❖ Cellular network divides coverage area into cells, each served by its own base station transceiver and antenna
- ❖ Low (er) power transmitters used by BSs; transmission range determines cell boundary
- ❖ RF spectrum divided into distinct groups of channels
- ❖ Adjacent cells are (usually) assigned different channel groups to avoid interference
- ❖ Cells separated by a sufficiently large distance to avoid mutual interference can be assigned the same channel group \Rightarrow frequency reuse among co-channel cells

Cellular Systems: Reuse channels to maximize capacity

- Geographic region divided into cells
- Frequencies/timeslots/codes reused at spatially-separated locations.
- Co-channel interference between same color cells.
- Base stations/MTSOs coordinate handoff and control functions
- Shrinking cell size increases capacity, as well as networking burden

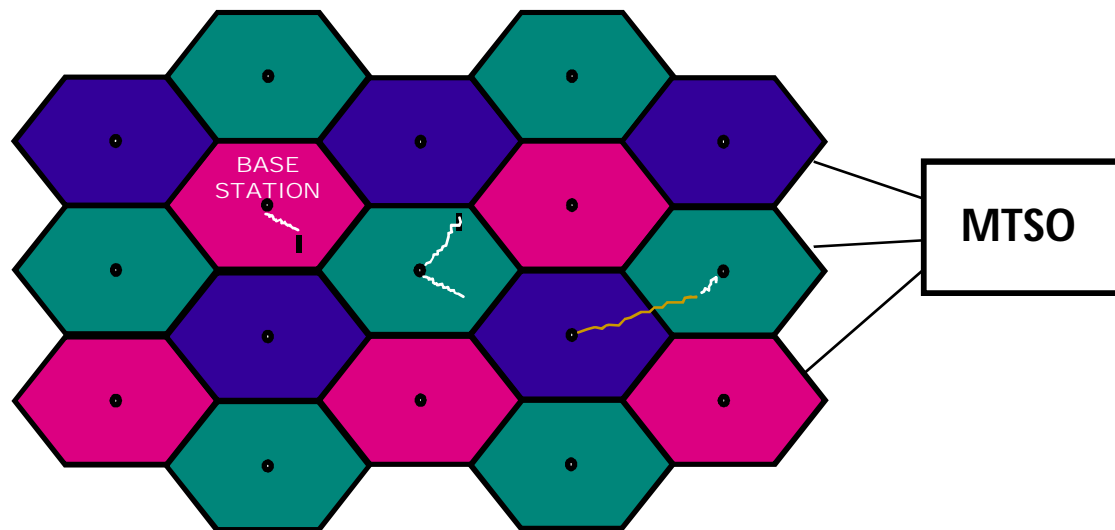

Trends in Cellular radio and Personal Communications

- ❖ PCS/PCN: PCS calls for more personalized services whereas PCN refers to Wireless Networking Concept-any person, anywhere, anytime can make a call using PC. PCS and PCN terms are sometime used interchangeably
- ❖ IEEE 802.11: A standard for computer communications using wireless links[inside building].
- ❖ ETSI's 20 Mbps HIPER LAN: Standard for indoor Wireless Networks
- ❖ IMT-2000 [International Mobile Telephone-2000 Standard]: A 3G universal, multi-function, globally compatible Digital Mobile Radio Standard is in making
- ❖ Satellite-based Cellular Phone Systems
- ❖ A very good Chance for Developing Nations to Improve their Communication Networks

UNIT II

CELLULAR CONCEPT AND SYSTEM DESIGN FUNDAMENTALS

2.1 Introduction to Cellular Systems

- Solves the problem of spectral congestion and user capacity.
- Offer very high capacity in a limited spectrum without major technological changes.
- Reuse of radio channel in different cells.
- Enable a fix number of channels to serve an arbitrarily large number of users by reusing the channel throughout the coverage region.

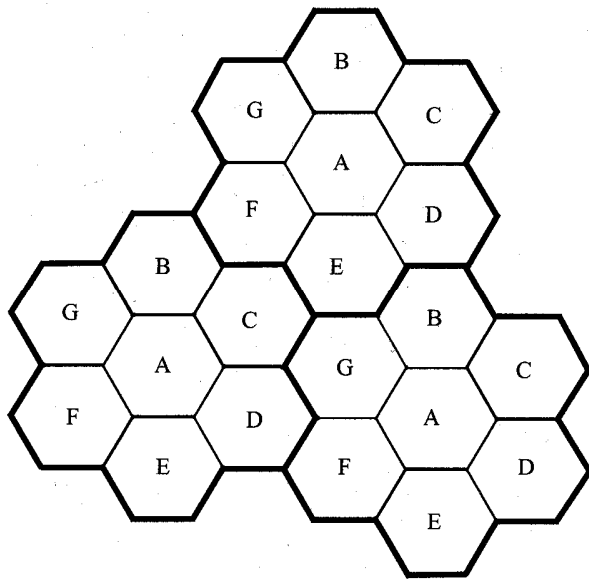

Frequency Reuse

- Each cellular base station is allocated a group of radio channels within a small geographic area called a *cell*.
- Neighboring cells are assigned different channel groups.
- By limiting the coverage area to within the boundary of the cell, the channel groups may be reused to cover different cells.
- Keep interference levels within tolerable limits.
- Frequency reuse or frequency planning

- seven groups of channel from A to G
- footprint of a cell - actual radio coverage
- omni-directional antenna v.s. directional antenna

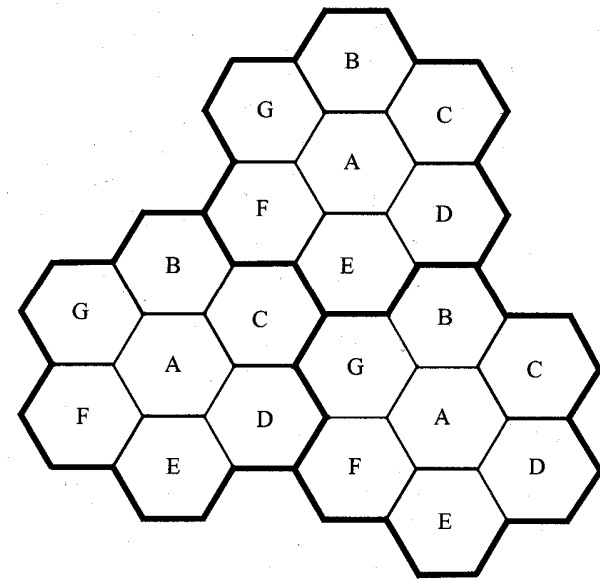

- Hexagonal geometry has
 - exactly six equidistance neighbors
 - the lines joining the centers of any cell and each of its neighbors are separated by multiples of 60 degrees.
- Only certain cluster sizes and cell layout are possible.
- The number of cells per cluster, N , can only have values which satisfy

$$N = i^2 + ij + j^2$$

- Co-channel neighbors of a particular cell, ex, $i=3$ and $j=2$.

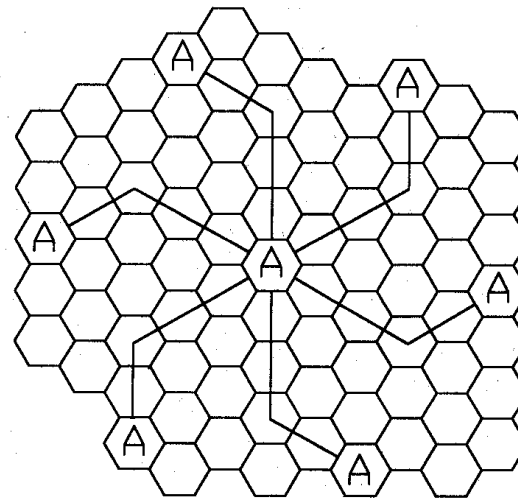

Channel Assignment Strategies

- Frequency reuse scheme
 - increases capacity
 - minimize interference
- Channel assignment strategy
 - fixed channel assignment
 - dynamic channel assignment
- Fixed channel assignment
 - each cell is allocated a predetermined set of voice channel
 - any new call attempt can only be served by the unused channels
 - the call will be *blocked* if all channels in that cell are occupied
- Dynamic channel assignment
 - channels are not allocated to cells permanently.
 - allocate channels based on request.
 - reduce the likelihood of blocking, increase capacity.

2.4 Handoff Strategies

- When a mobile moves into a different cell while a conversation is in progress, the MSC automatically transfers the call to a new channel belonging to the new base station.
- Handoff operation
 - identifying a new base station
 - re-allocating the voice and control channels with the new base station.
- Handoff Threshold
 - Minimum usable signal for acceptable voice quality (-90dBm to -100dBm)
 - Handoff margin $\Delta = P_{r,handoff} - P_{r,minimum\ usable}$ cannot be too large or too small.
 - If Δ is too large, unnecessary handoffs burden the MSC
 - If Δ is too small, there may be insufficient time to complete handoff before a call is lost.

(a) Improper handoff situation

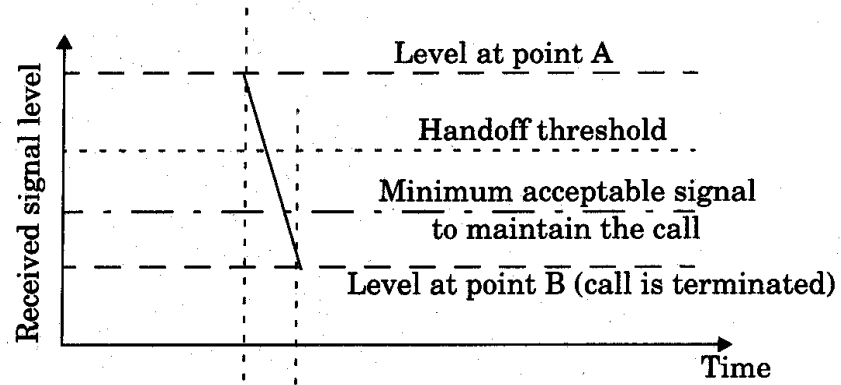

(b) Proper handoff situation

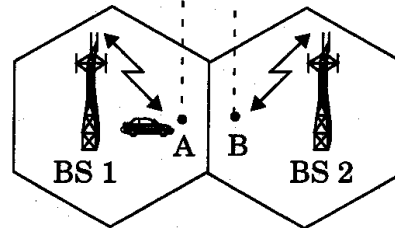
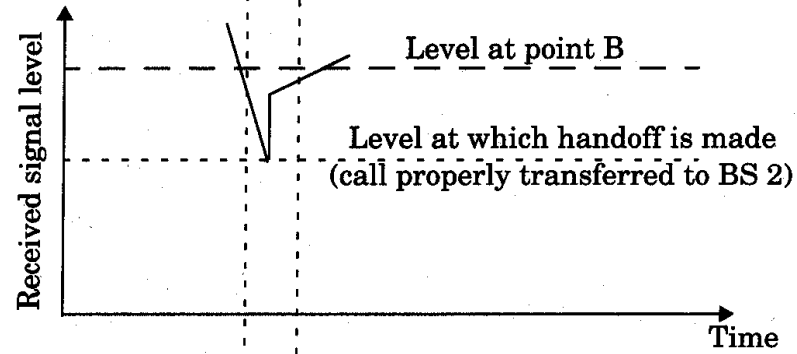

- Handoff must ensure that the drop in the measured signal is not due to momentary fading and that the mobile is actually moving away from the serving base station.
- Running average measurement of signal strength should be optimized so that unnecessary handoffs are avoided.
 - Depends on the speed at which the vehicle is moving.
 - Steep short term average -> the hand off should be made quickly
 - The speed can be estimated from the statistics of the received short-term fading signal at the base station
- Dwell time: the time over which a call may be maintained within a cell without handoff.
- Dwell time depends on
 - propagation
 - interference
 - distance
 - speed

- Handoff measurement
 - In first generation analog cellular systems, signal strength measurements are made by the base station and supervised by the MSC.
 - In second generation systems (TDMA), handoff decisions are mobile assisted, called mobile assisted handoff (MAHO)
- Intersystem handoff: If a mobile moves from one cellular system to a different cellular system controlled by a different MSC.
- Handoff requests is much important than handling a new call.

Practical Handoff Consideration

- Different type of users
 - High speed users need frequent handoff during a call.
 - Low speed users may never need a handoff during a call.
- Microcells to provide capacity, the MSC can become burdened if high speed users are constantly being passed between very small cells.
- Minimize handoff intervention
 - handle the simultaneous traffic of high speed and low speed users.
- Large and small cells can be located at a single location (umbrella cell)
 - different antenna height
 - different power level
- Cell dragging problem: pedestrian users provide a very strong signal to the base station
 - The user may travel deep within a neighboring cell



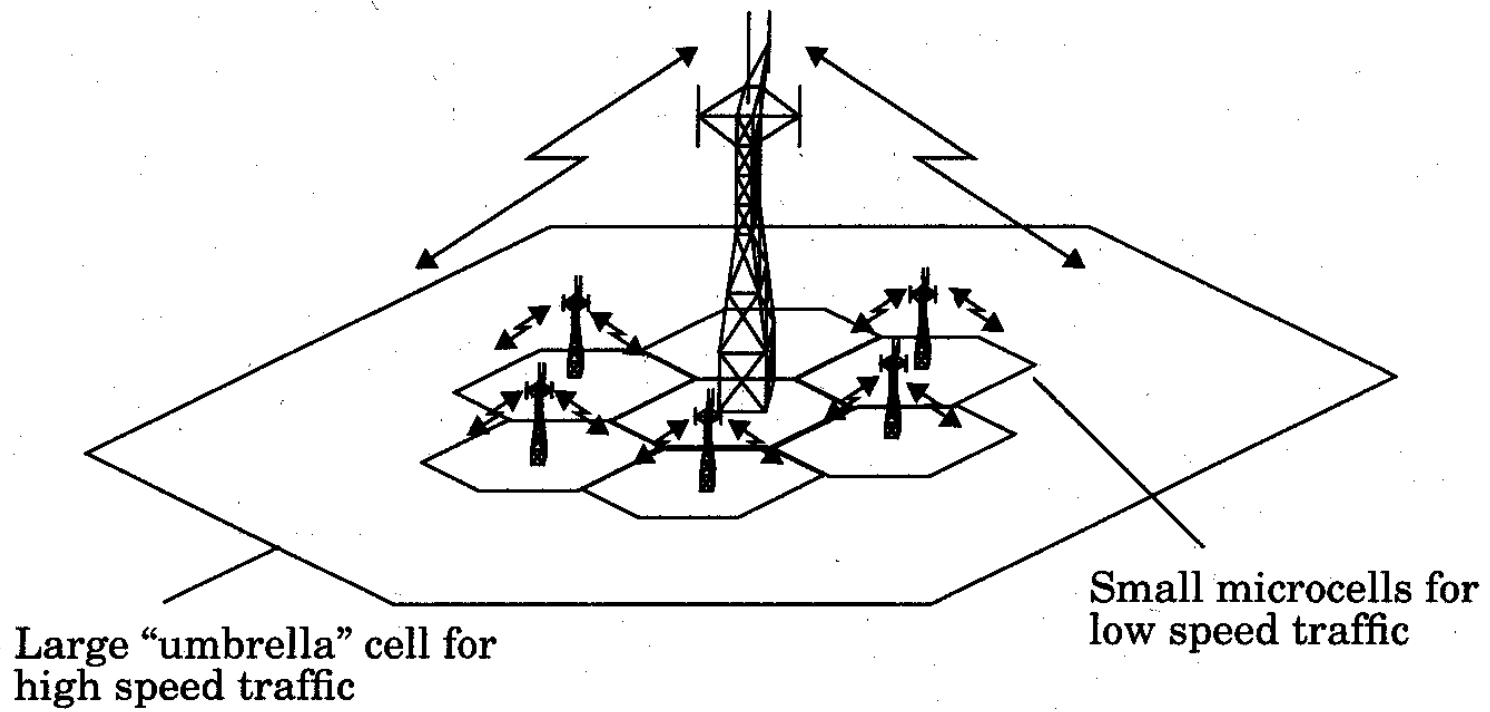

- Handoff for first generation analog cellular systems
 - 10 secs handoff time
 - Δ is in the order of 6 dB to 12 dB
- Handoff for second generation cellular systems, e.g., GSM
 - 1 to 2 seconds handoff time
 - mobile assists handoff
 - Δ is in the order of 0 dB to 6 dB
 - Handoff decisions based on signal strength, co-channel interference, and adjacent channel interference.
- IS-95 CDMA spread spectrum cellular system
 - Mobiles share the channel in every cell.
 - No physical change of channel during handoff
 - MSC decides the base station with the best receiving signal as the service station

-

Types of Handoffs:

- ❖ Hard handoff: “break before make” connection
- ❖ Intra and inter-cell handoffs

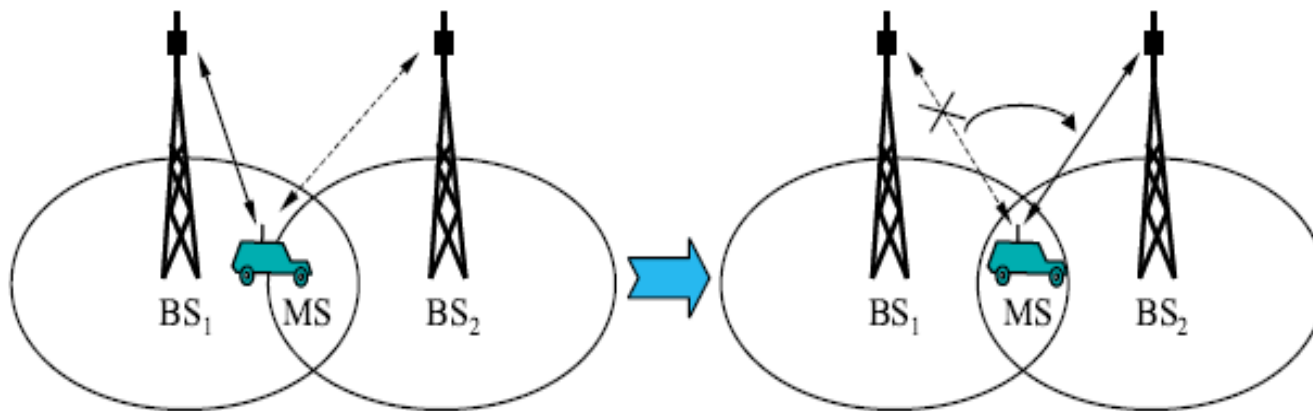

Hard Handoff between the MS and BSs

Cont.

- ❖ Soft handoff: “make-before-break” connection.
- ❖ Mobile directed handoff.
- ❖ Multiways and softer handoffs

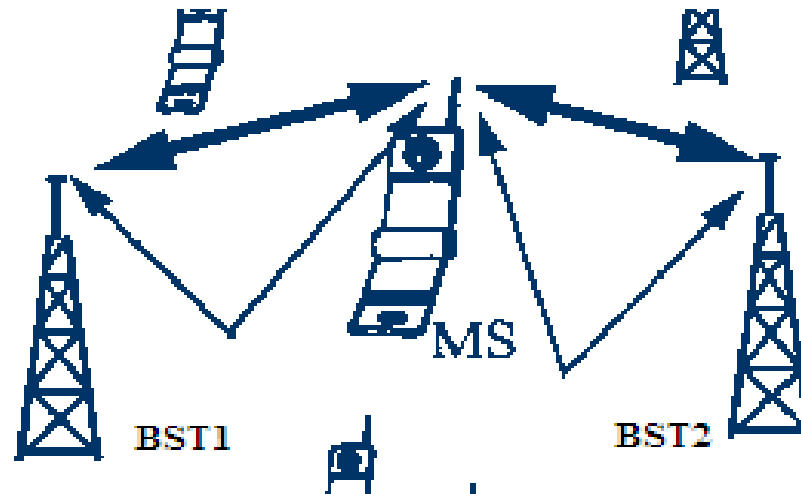

Soft Handoff between MS and BSTs

Handoff Prioritization:

Two basic methods of handoff prioritization are :

- ❖ Guard Channels
- ❖ Queuing of Handoff

2.5 Interference and System Capacity

- Sources of interference
 - another mobile in the same cell
 - a call in progress in the neighboring cell
 - other base stations operating in the same frequency band
 - noncellular system leaks energy into the cellular frequency band
- Two major cellular interference
 - co-channel interference
 - adjacent channel interference



2.5.1 Co-channel Interference and System Capacity

- Frequency reuse - there are several cells that use the same set of frequencies
 - co-channel cells
 - co-channel interference
- To reduce co-channel interference, co-channel cell must be separated by a minimum distance.
- When the size of the cell is approximately the same
 - co-channel interference is independent of the transmitted power
 - co-channel interference is a function of
 - R : Radius of the cell
 - D : distance to the center of the nearest co-channel cell
- Increasing the ratio $Q=D/R$, the interference is reduced.
- Q is called the co-channel reuse ratio



- For a hexagonal geometry

$$Q = \frac{D}{R} = \sqrt{3N}$$

- A small value of Q provides large capacity
- A large value of Q improves the transmission quality - smaller level of co-channel interference
- A tradeoff must be made between these two objectives

Table 2.1 Co-channel Reuse Ratio for Some Values of N

	Cluster Size (M)	Co-channel Reuse Ratio(Q)
$i = 1, j = 1$	3	3
$i = 1, j = 2$	7	4.58
$i = 2, j = 2$	12	6
$i = 1, j = 3$	13	6.24

- Let i_0 be the number of co-channel interfering cells. The signal-to-interference ratio (SIR) for a mobile receiver can be expressed as

$$\frac{S}{I} = \frac{S}{\sum_{i=1}^{i_0} I_i}$$

S : the desired signal power

I_i : interference power caused by the i th interfering co-channel cell base station

- The average received power at a distance d from the transmitting antenna is approximated by

$$P_r = P_0 \left(\frac{d}{d_0} \right)^{-n}$$

or

$$P_r(\text{dBm}) = P_0(\text{dBm}) - 10n \log \left(\frac{d}{d_0} \right)$$

n is the path loss exponent which ranges between 2 and 4.

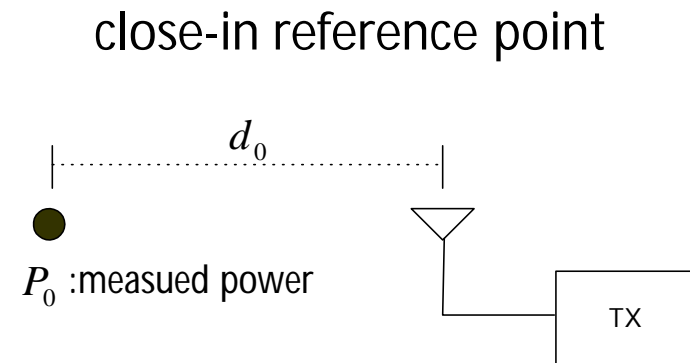

- When the transmission power of each base station is equal, SIR for a mobile can be approximated as

$$\frac{S}{I} = \frac{R^{-n}}{\sum_{i=1}^{i_0} (D_i)^{-n}}$$

- Consider only the first layer of interfering cells

$$\frac{S}{I} = \frac{(D/R)^n}{i_0} = \frac{(\sqrt{3N})^n}{i_0} \quad i_0 = 6$$

- Example: AMPS requires that SIR be greater than 18dB
 - N should be at least 6.49 for $n=4$.
 - Minimum cluster size is 7

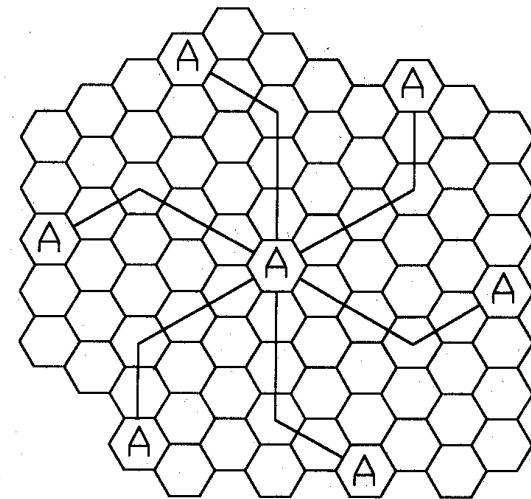

- For hexagonal geometry with 7-cell cluster, with the mobile unit being at the cell boundary, the signal-to-interference ratio for the worst case can be approximated as

$$\frac{S}{I} = \frac{R^{-4}}{2(D-R)^{-4} + (D-R/2)^{-4} + (D+R/2)^{-4} + (D+R)^{-4} + D^{-4}}$$

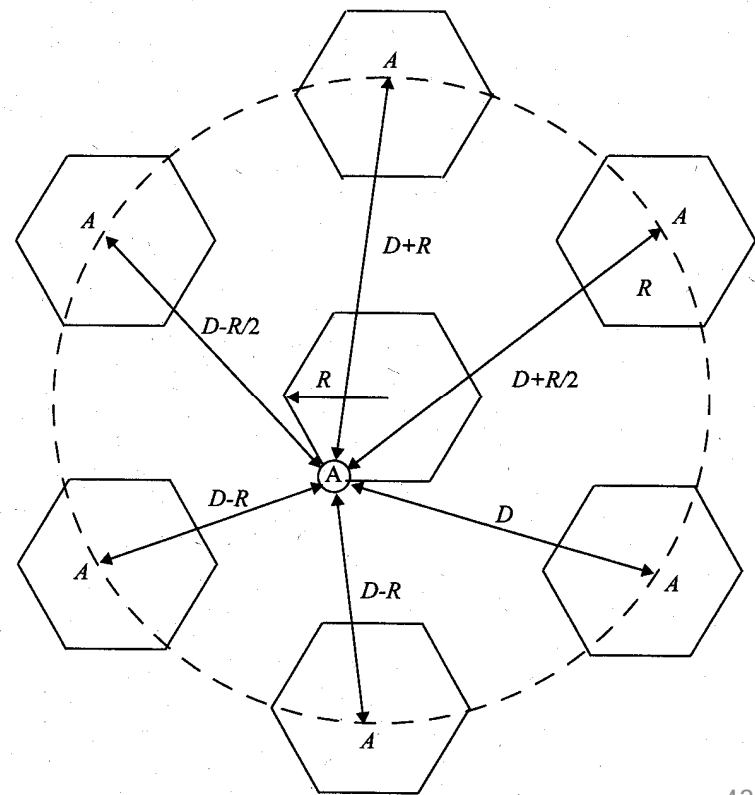

2.5.2 Adjacent Channel Interference

- Adjacent channel interference: interference from adjacent in frequency to the desired signal.
 - Imperfect receiver filters allow nearby frequencies to leak into the passband
 - Performance degrade seriously due to *near-far* effect.

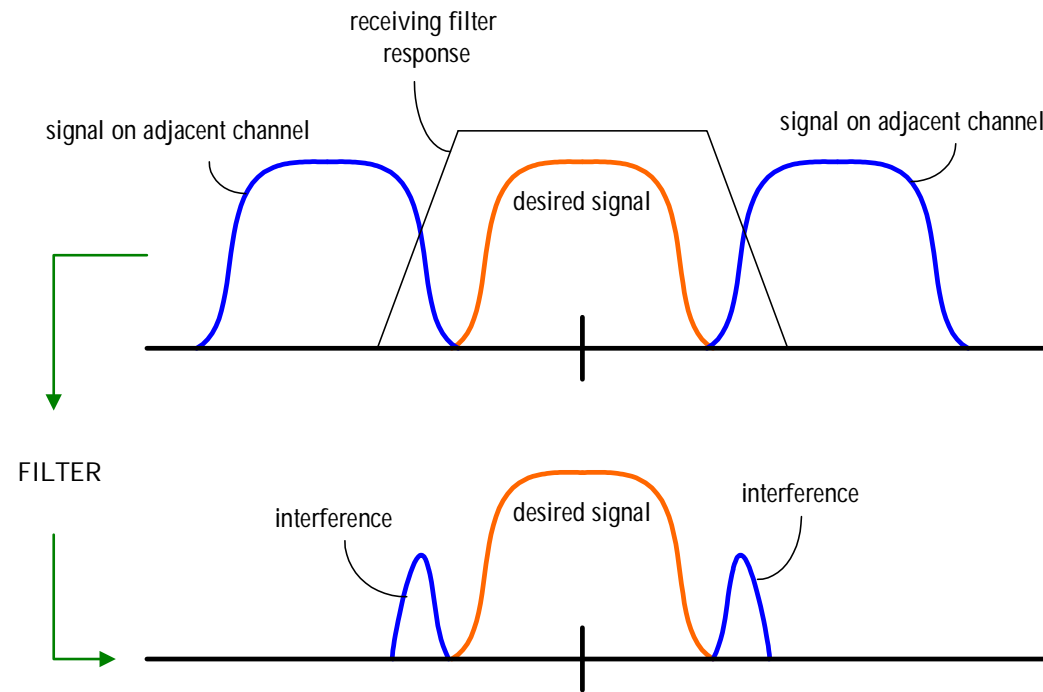

- Adjacent channel interference can be minimized through careful filtering and *channel assignment*.
- Keep the frequency separation between each channel in a given cell as large as possible
- A channel separation greater than six is needed to bring the adjacent channel interference to an acceptable level.
- Ensure each mobile transmits the smallest power necessary to maintain a good quality link on the reverse channel
 - long battery life
 - increase SIR
 - solve the near-far problem

Trunking and Grade of Service

- ❖ A means for providing access to users on demand from available pool of channels.
- ❖ With trunking, a small number of channels can accommodate large number of random users.
- ❖ Telephone companies use trunking theory to determine number of circuits required.
- ❖ Trunking theory is about how a population can be handled by a limited number of servers.

Terminology:

- ❖ Traffic intensity is measured in Erlangs:
- ❖ One Erlang: traffic in a channel completely occupied. 0.5 Erlang: channel occupied 30 minutes in an hour.
- ❖ Grade of Service (GOS): probability that a call is blocked (or delayed).
- ❖ Set-Up Time: time to allocate a channel.
- ❖ Blocked Call: Call that cannot be completed at time of request due to congestion. Also referred to as Lost Call.
- ❖ Holding Time: (H) average duration of typical call.
- ❖ Load: Traffic intensity across the whole system.
- ❖ Request Rate: (λ) average number of call requests per unit time.

Traffic Measurement (Erlangs)

- ❑ Traffic per user $A_u = \lambda H$ where λ is the request rate and H is the holding time.
- ❑ For U users the load is $A = UA_u$
- ❑ If traffic is trunked in C channels, then the traffic intensity per channel is $A_c = UA_u / C$

Erlang B: If blocked calls are cleared (i.e. not queued), then under some model assumptions, the probability of a blocked call is given by the Erlang B model:

$$\Pr[\text{blocking}] = \frac{\frac{A^c}{C!}}{\sum_{k=0}^c \frac{A^k}{k!}} = GOS$$

Number of Channels C	Capacity (Erlangs) for GOS			
	= 0.01	= 0.005	= 0.002	= 0.001
2	0.153	0.105	0.065	0.046
4	0.869	0.701	0.535	0.439
5	1.36	1.13	0.900	0.762
10	4.46	3.96	3.43	3.09
20	12.0	11.1	10.1	9.41
24	15.3	14.2	13.0	12.2
40	29.0	27.3	25.7	24.5
70	56.1	53.7	51.0	49.2
100	84.1	80.9	77.4	75.2

Table 3.4: Capacity of Erlang B System

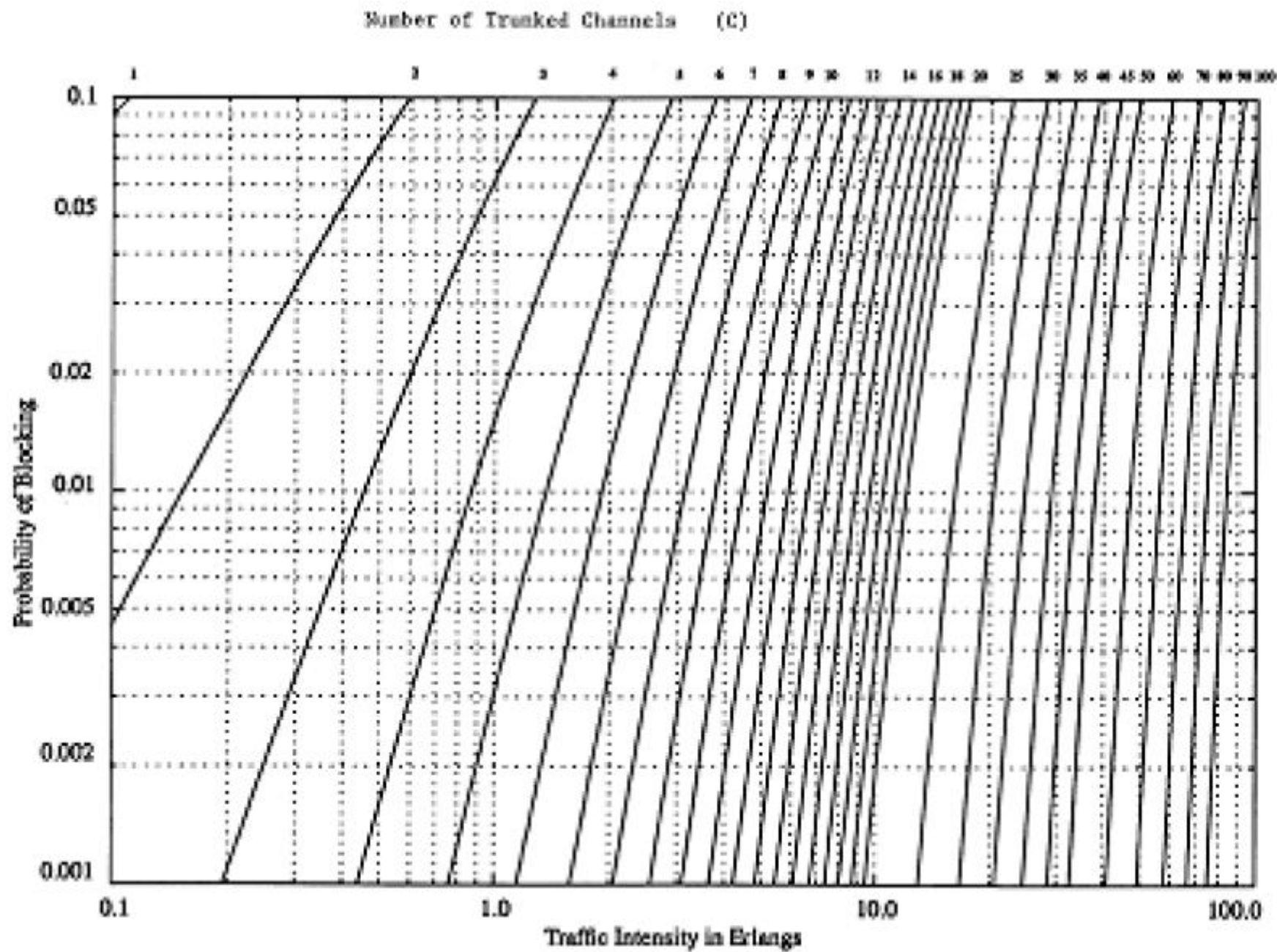

Figure 3.6: The Erlang B chart showing the probability of blocking vs. traffic intensity

Example 3.4

How many users can be supported for 0.5% blocking probability for the following number of trunked channels in a blocked calls cleared system? (a) 1, (b) 5, (c) 10, (d) 20, (e) 100. Assume each user generates 0.1 Erlangs of traffic.

The required GOS = 0.5%. Each user generates 0.1 Erlangs of traffic. How many users in a blocked channels cleared system for $C = 5$ channels?

From the chart, with GOS=0.005 and the number of channels (C) = 5:

A (capacity in Erlangs) = 1.13

$\Rightarrow U = A/A_u = 1.13/0.1 \sim 11$ users.

Example 3.5

An urban area has a population of two million residents. Three competing trunked mobile networks (systems A, B, and C) provide cellular service in this area. System A has 394 cells with 19 channels each, system B has 98 cells with 57 channels each, and system C has 49 cells, each with 100 channels. Find the number of users that can be supported at 2% blocking if each user averages two calls per hour at an average call duration of three minutes. Assuming that all three trunked systems are operated at maximum capacity, compute the percentage market penetration of each cellular provider.

Solution

System A

Given:

Probability of blocking = 2% = 0.02

Number of channels per cell used in the system, $C = 19$

Traffic intensity per user, $A_u = \lambda H = 2 \times (3/60) = 0.1$ Erlangs

For $GOS = 0.02$ and $C = 19$, from the Erlang B chart, the total carried traffic, A , is obtained as 12 Erlangs.

Therefore, the number of users that can be supported per cell is

$$U = A/A_u = 12/0.1 = 120$$

Since there are 394 cells, the total number of subscribers that can be supported by System A is equal to $120 \times 394 = 47280$

System B

Given:

Probability of blocking = 2% = 0.02

Number of channels per cell used in the system, $C = 57$

Traffic intensity per user, $A_u = \lambda H = 2 \times (3/60) = 0.1$ Erlangs

For $GOS = 0.02$ and $C = 57$, from the Erlang B chart, the total carried traffic, A , is obtained as 45 Erlangs.

Therefore, the number of users that can be supported per cell is

$$U = A/A_u = 45/0.1 = 450$$

Since there are 98 cells, the total number of subscribers that can be supported by System B is equal to $450 \times 98 = 44,100$

System C

Given:

Probability of blocking = 2% = 0.02

Number of channels per cell used in the system, $C = 100$

Traffic intensity per user, $A_u = \lambda H = 2 \times (3/60) = 0.1$ Erlangs

For $GOS = 0.02$ and $C = 100$, from the Erlang B chart, the total carried traffic, A , is obtained as 88 Erlangs.

Therefore, the number of users that can be supported per cell is

$$U = A/A_u = 88/0.1 = 880$$

Since there are 49 cells, the total number of subscribers that can be supported by System C is equal to $880 \times 49 = 43,120$

Therefore, total number of cellular subscribers that can be supported by these three systems are $47,280 + 44,100 + 43,120 = 134,500$ users.

Since there are two million residents in the given urban area and the total number of cellular subscribers in System A is equal to 47280, the percentage market penetration is equal to

$$47,280/2,000,000 = 2.36\%$$

Similarly, market penetration of System B is equal to

$$44,100/2,000,000 = 2.205\%$$

and the market penetration of System C is equal to

$$43,120/2,000,000 = 2.156\%$$

The market penetration of the three systems combined is equal to

$$134,500/2,000,000 = 6.725\%$$

Erlang C Model –Blocked calls cleared

- ❖ A different type of trunked system queues blocked calls –Blocked Calls Delayed. This is known as an Erlang C model.
- ❖ Procedure:
 - ❖ Determine $\Pr[\text{delay} > 0]$ = probability of a delay from the chart.
 - ❖ $\Pr[\text{delay} \square > t \mid \text{delay} \square > 0]$ = probability that the delay is longer than t, given that there is a delay
 - ❖ $\Pr[\text{delay} \square > t \mid \text{delay} \square > 0] = \exp[-(C-A)t / H]$
 - ❖ Unconditional Probability of delay $\square > t$:
 - ❖ $\Pr[\text{delay} \square > t] = \Pr[\text{delay} \square > 0] \Pr[\text{delay} \square > t \mid \text{delay} \square > 0]$
 - ❖ Average delay time $D = \Pr[\text{delay} \square > 0] H / (C-A)$

Erlang C Formula

- ❖ The likelihood of a call not having immediate access to a channel is determined by Erlang C formula:

$$\Pr[\text{delay} > 0] = \frac{A^C}{A^C + C! \left(1 - \frac{A}{C}\right) \sum_{k=0}^{C-1} \frac{A^k}{k!}}$$

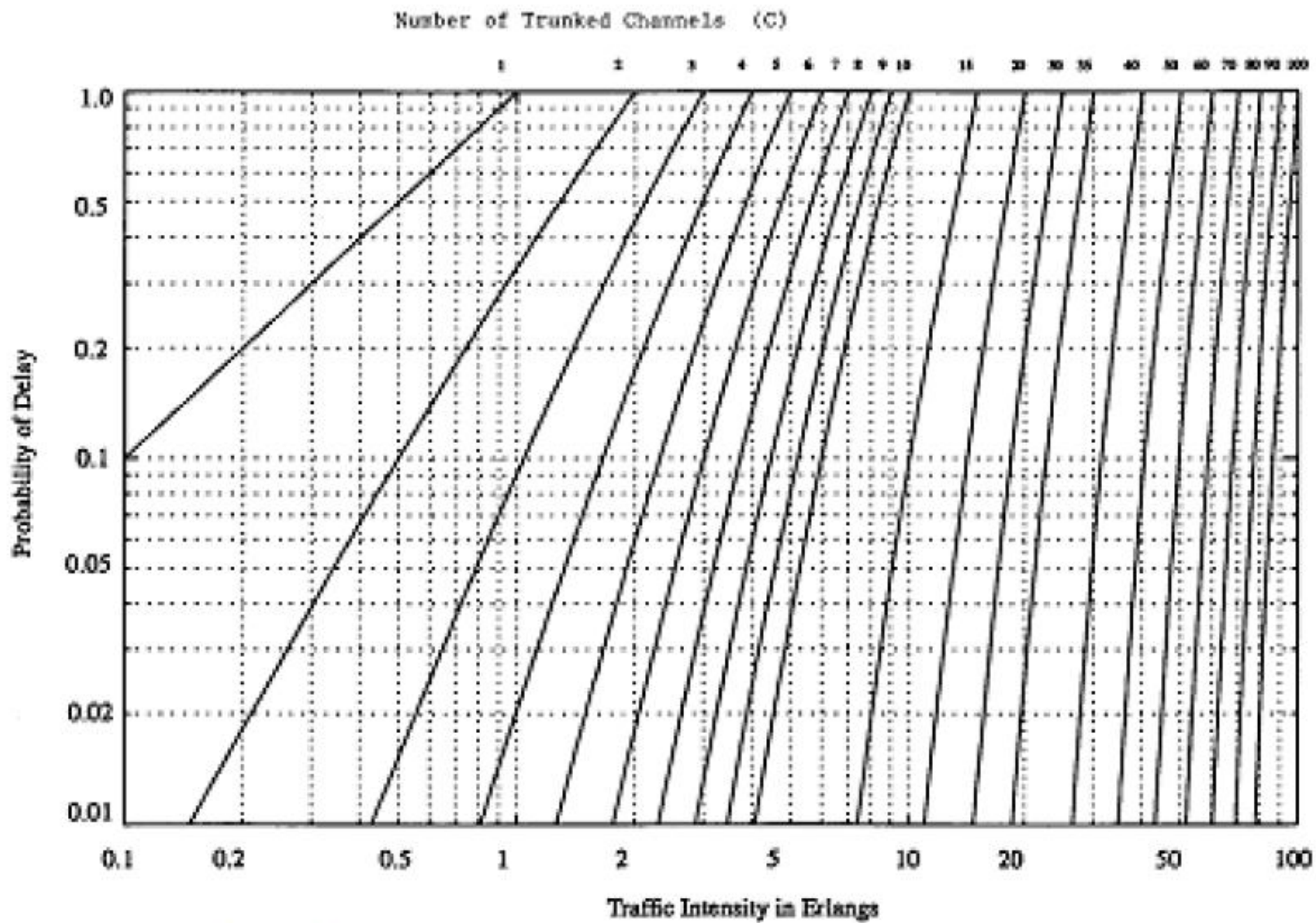

Figure 3.7: The Erlang C chart showing the probability of delay vs. traffic intensity

Example 3.7

A hexagonal cell within a four-cell system has a radius of 1.387 km. A total of 60 channels are used within the entire system. If the load per user is 0.029 Erlangs, and $\lambda = 1$ call/hour, compute the following for an Erlang C system that has a 5% probability of a delayed call:

- (a) How many users per square kilometer will this system support?
- (b) What is the probability that a delayed call will have to wait for more than 10 s?
- (c) What is the probability that a call will be delayed for more than 10 seconds?

Solution

Given:

Cell radius, $R = 1.387$ km

Area covered per cell is $2.598 \times (1.387)^2 = 5$ sq km

Number of cells per cluster = 4

Total number of channels = 60

Therefore, number of channels per cell = $60 / 4 = 15$ channels.

- (a) From Erlang C chart, for 5% probability of delay with $C = 15$, traffic intensity = 9.0 Erlangs.

Therefore, number of users = total traffic intensity / traffic per user
= $9.0/0.029 = 310$ users
= $310 \text{ users}/5 \text{ sq km} = 62 \text{ users/sq km}$

- (b) Given $\lambda = 1$, holding time

$$H = A_v/\lambda = 0.029 \text{ hour} = 104.4 \text{ seconds.}$$

The probability that a delayed call will have to wait longer than 10 s is

$$\begin{aligned} Pr[\text{delay} > t | \text{delay}] &= \exp(-(C - A)t/H) \\ &= \exp(-(15 - 9.0)10/104.4) = 56.29\% \end{aligned}$$

- (c) Given $Pr[\text{delay} > 0] = 5\% = 0.05$

Probability that a call is delayed more than 10 seconds,

$$\begin{aligned} Pr[\text{delay} > 10] &= Pr[\text{delay} > 0]Pr[\text{delay} > t | \text{delay}] \\ &= 0.05 \times 0.5629 = 2.81\% \end{aligned}$$

2.7 Improving Capacity in Cellular Systems

- Methods for improving capacity in cellular systems
 - Cell Splitting: subdividing a congested cell into smaller cells.
 - Sectoring: directional antennas to control the interference and frequency reuse.
 - Coverage zone : Distributing the coverage of a cell and extends the cell boundary to hard-to-reach place.



Cell Splitting

- ❖ Cell Splitting is the process of subdividing the congested cell into smaller cells (microcells), Each with its own base station and a corresponding reduction in antenna height and transmitter power.
- ❖ Cell Splitting increases the capacity since it increases the number of times the channels are reused.

2.7.1 Cell Splitting

- Split congested cell into smaller cells.
 - Preserve frequency reuse plan.
 - Reduce transmission power.

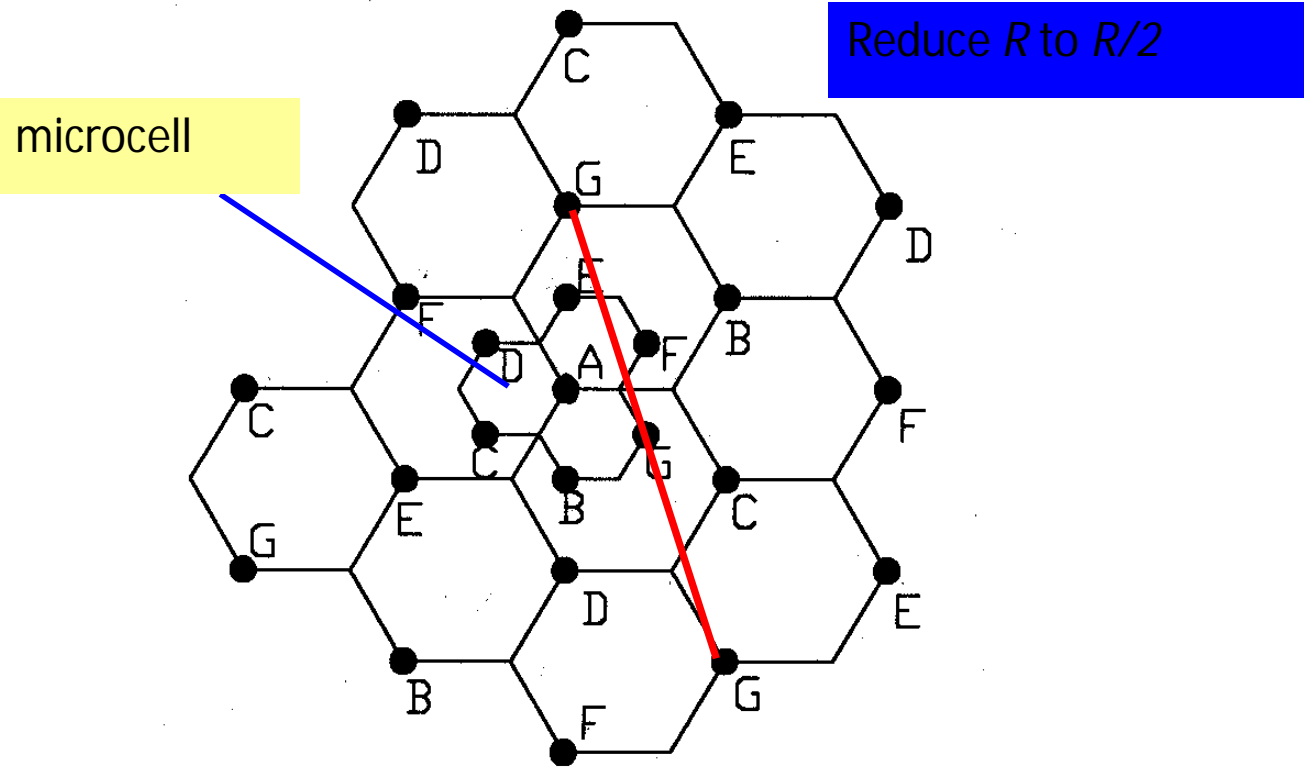
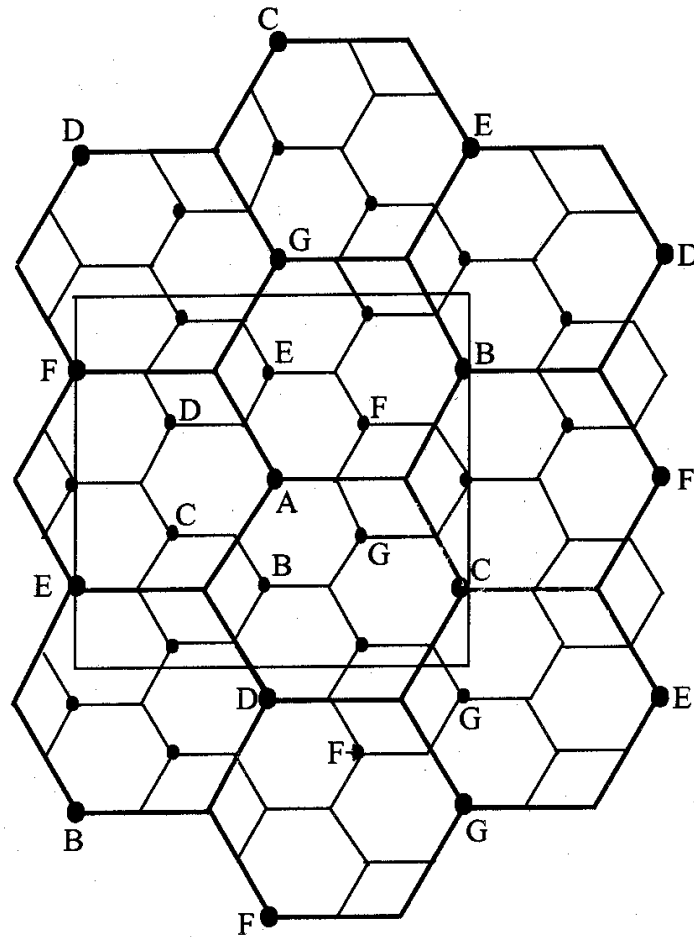

Illustration of cell splitting within a 3 km by 3 km square



- Transmission power reduction from P_{t1} to P_{t2}
- Examining the receiving power at the new and old cell boundary

$$P_r[\text{at old cell boundary}] \propto P_{t1} R^{-n}$$

$$P_r[\text{at new cell boundary}] \propto P_{t2} (R/2)^{-n}$$

- If we take $n = 4$ and set the received power equal to each other

$$P_{t2} = \frac{P_{t1}}{16}$$

- The transmit power must be reduced by 12 dB in order to fill in the original coverage area.
- Problem: if only part of the cells are split
 - Different cell sizes will exist simultaneously
- Handoff issues - high speed and low speed traffic can be simultaneously accommodated

2.7.2 Sectoring

- Decrease the *co-channel interference* and keep the cell radius R unchanged
 - Replacing single omni-directional antenna by several directional antennas
 - Radiating within a specified sector

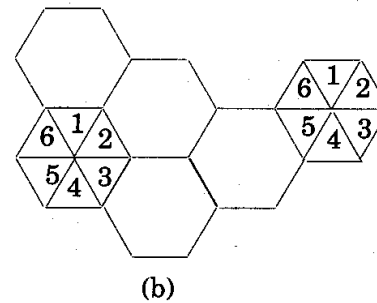
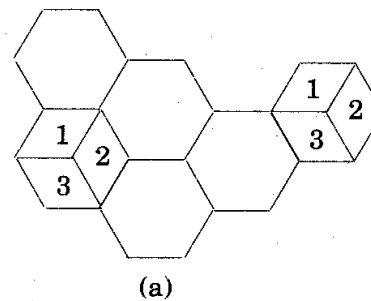

- Interference Reduction

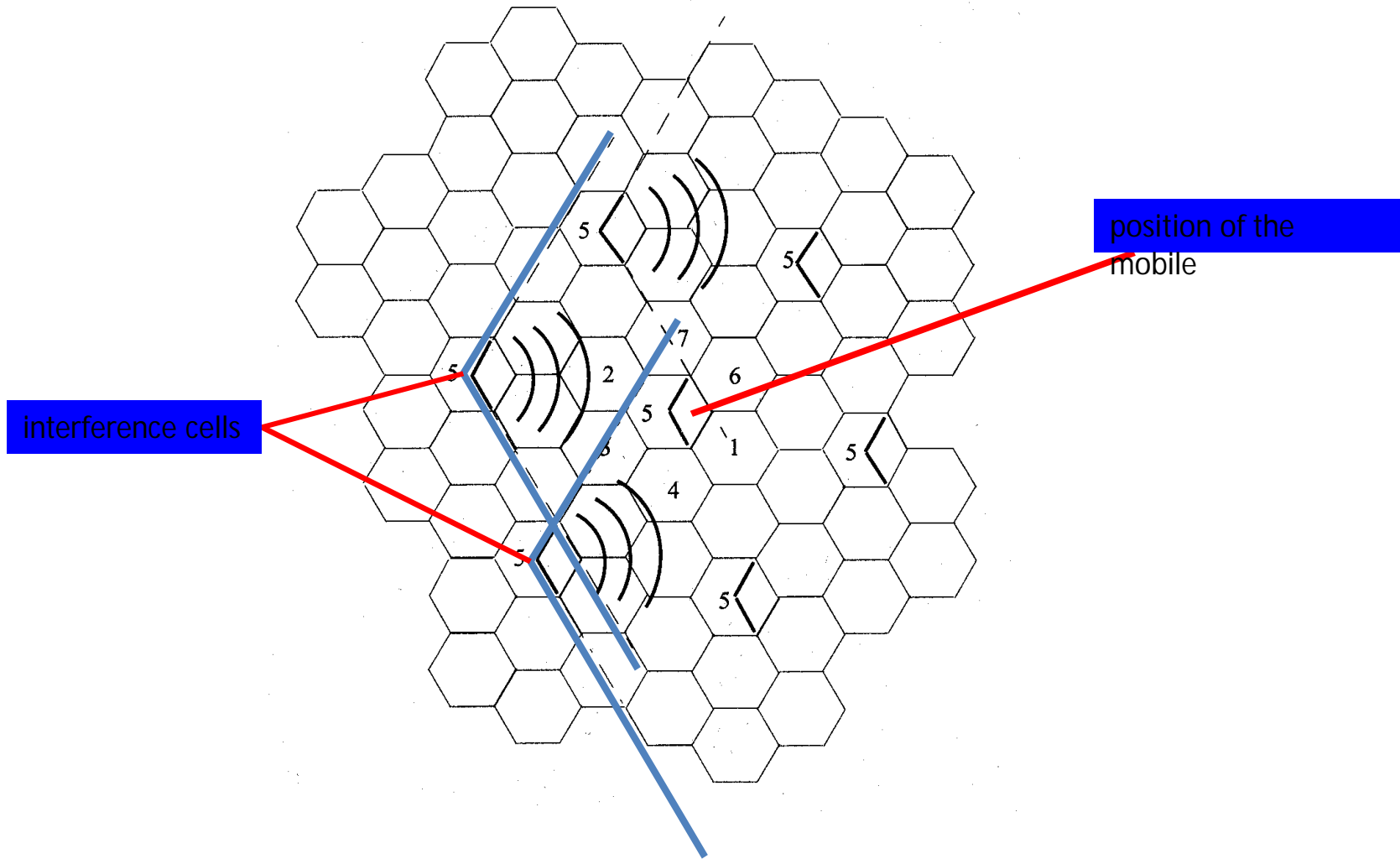

2.7.3 Microcell Zone Concept

- Antennas are placed at the outer edges of the cell
 - Any channel may be assigned to any zone by the base station
 - Mobile is served by the zone with the strongest signal.
-
- Handoff within a cell
 - No channel re-assignment
 - Switch the channel to a different zone site
 - Reduce interference
 - Low power transmitters are employed

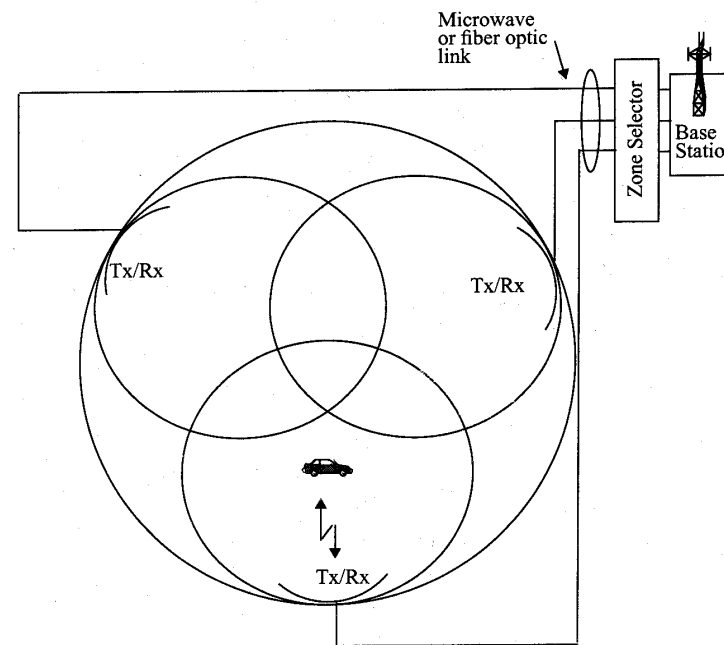

Multiple Access Techniques for Wireless Communication:

Many users can access the at same time, share a finite amount of radio spectrum with high performance duplexing generally required frequency domain time domain. They accessing techniques are,

- ❖ FDMA
- ❖ TDMA
- ❖ SDMA
- ❖ PDMA

Frequency division multiple access FDMA

- ❖ One phone circuit per channel
- ❖ Idle time causes wasting of resources
- ❖ Simultaneously and continuously transmitting
- ❖ Usually implemented in narrowband systems
- ❖ For example: in AMPS is a FDMA bandwidth of 30 kHz implemented

Time Division Multiple Access

- ❖ Time slots
- ❖ One user per slot
- ❖ Buffer and burst method
- ❖ Noncontinuous transmission
- ❖ Digital data
- ❖ Digital modulation

Features of TDMA

- ❖ A single carrier frequency for several users
- ❖ Transmission in bursts
- ❖ Low battery consumption
- ❖ Handoff process much simpler
- ❖ FDD : switch instead of duplexer
- ❖ Very high transmission rate
- ❖ High synchronization overhead
- ❖ Guard slots necessary

Space Division Multiple Access

- ❖ Controls radiated energy for each user in space
- ❖ using spot beam antennas
- ❖ base station tracks user when moving
- ❖ cover areas with same frequency:
 - ❖ TDMA or CDMA systems
 - ❖ cover areas with same frequency:
 - ❖ FDMA systems

Space Division Multiple Access

❖ primitive applications are “Sectorized antennas”

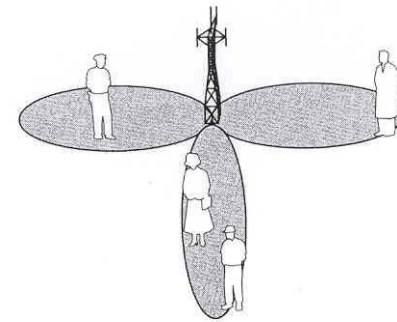

❖ In future adaptive antennas simultaneously steer energy in the direction of many users at once

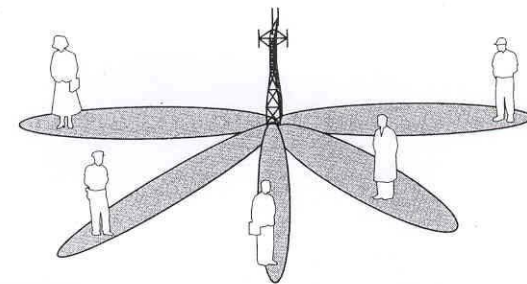

UNIT III

MOBILE RADIO PROPAGATION

. **Mobile Radio Propagation**

- RF channels are random – do not offer easy analysis
- difficult to model – typically done statistically for a specific system

Introduction to Radio Wave Propagation: diverse mechanisms of electromagnetic (EM) wave propagation generally attributed to

(i) diffraction

(ii) reflection

(iii) scattering

- non-line of sight (**NLOS – obstructed**) paths rely on reflections
- **obstacles** cause diffraction
- **multi-path:** EM waves travel on different paths to a destination – interaction of paths causes fades at specific locations

traditional **Propagation Models** focus on

- (i) **transmit model** - **average** received signal strength at given distance
- (ii) **receive model** - **variability** in signal strength near a given location

(1) Large Scale Propagation Models: predict mean signal strength for TX-RX pair with arbitrary separation

- useful for **estimating coverage area** of a transmitter
- characterizes signal strength over **large distances** (10^2 - 10^3 m)
- predict **local average signal** strength that decreases with distance

(2) Small Scale or Fading Models: characterize rapid fluctuations of received signal over

- short distances (*few λ*) or
- short durations (*few seconds*)

with **mobility** over short distances

- instantaneous signal strength fluctuates
- received signal = sum of many components from different directions
- phases are random \rightarrow sum of contributions varies widely
- received signal may fluctuate 30-40 dB by moving a fraction of λ

Large-scale small-scale propagation

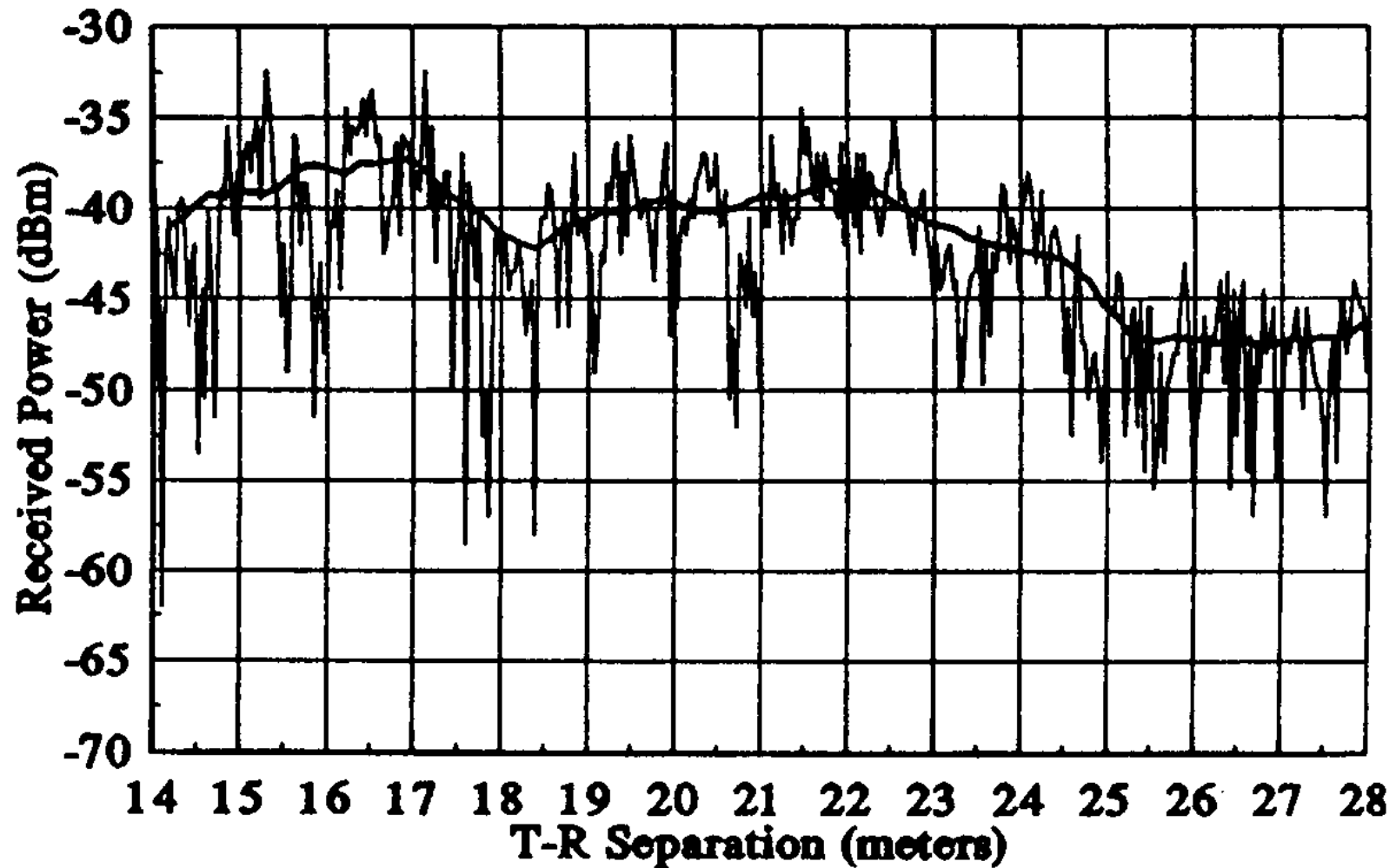

Reflection

- Perfect conductors reflect with no attenuation
 - Like light to the mirror
- Dielectrics reflect a fraction of incident energy
 - “Grazing angles” reflect max*
 - Steep angles transmit max*
 - Like light to the water
- Reflection induces 180° phase shift
 - Why? See yourself in the mirror

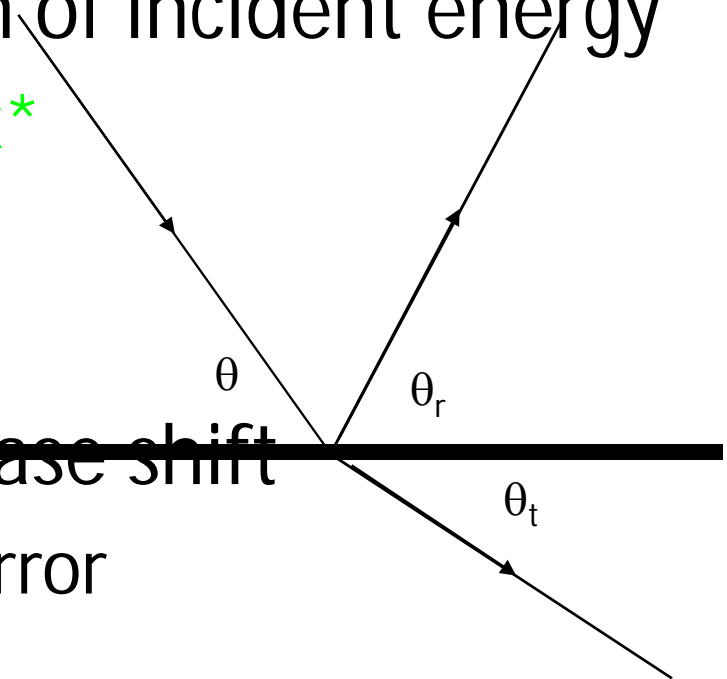

Classical 2-ray ground bounce model

- One line of sight and one ground bound

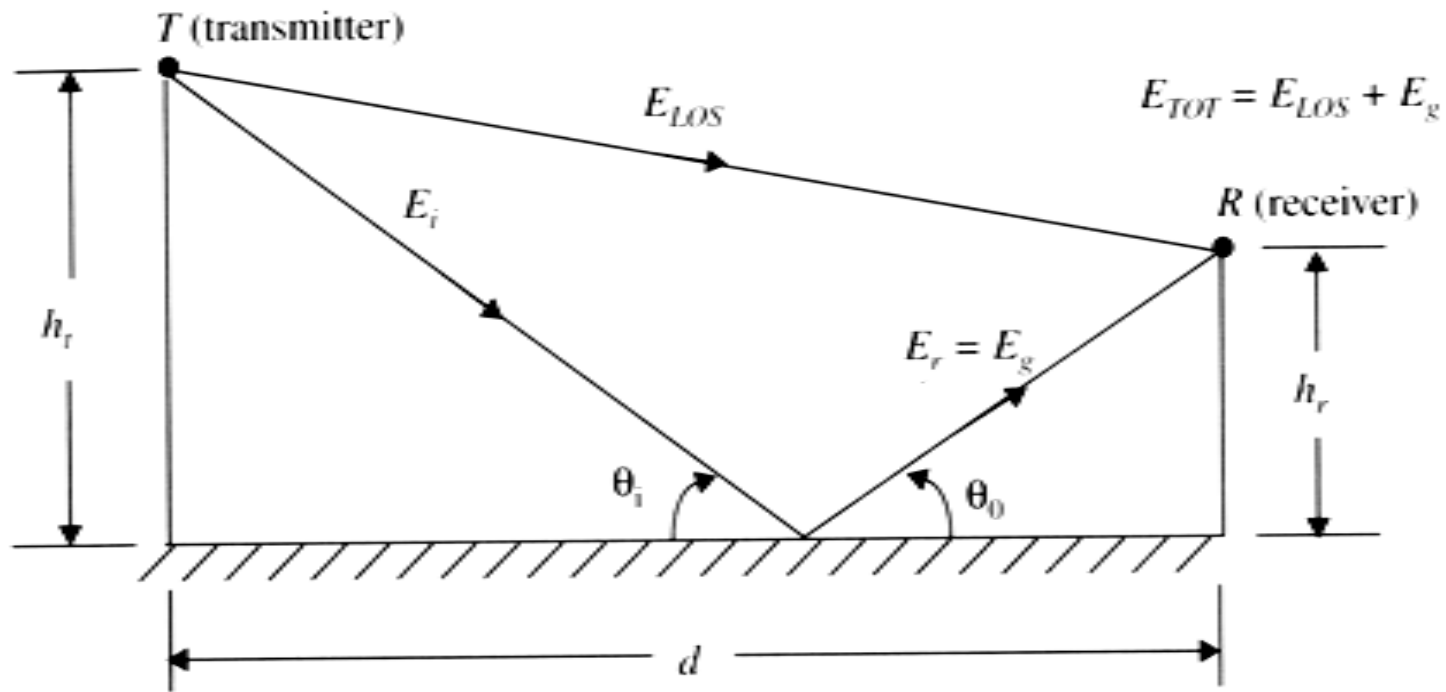

Figure 4.7 Two-ray ground reflection model.

Method of image

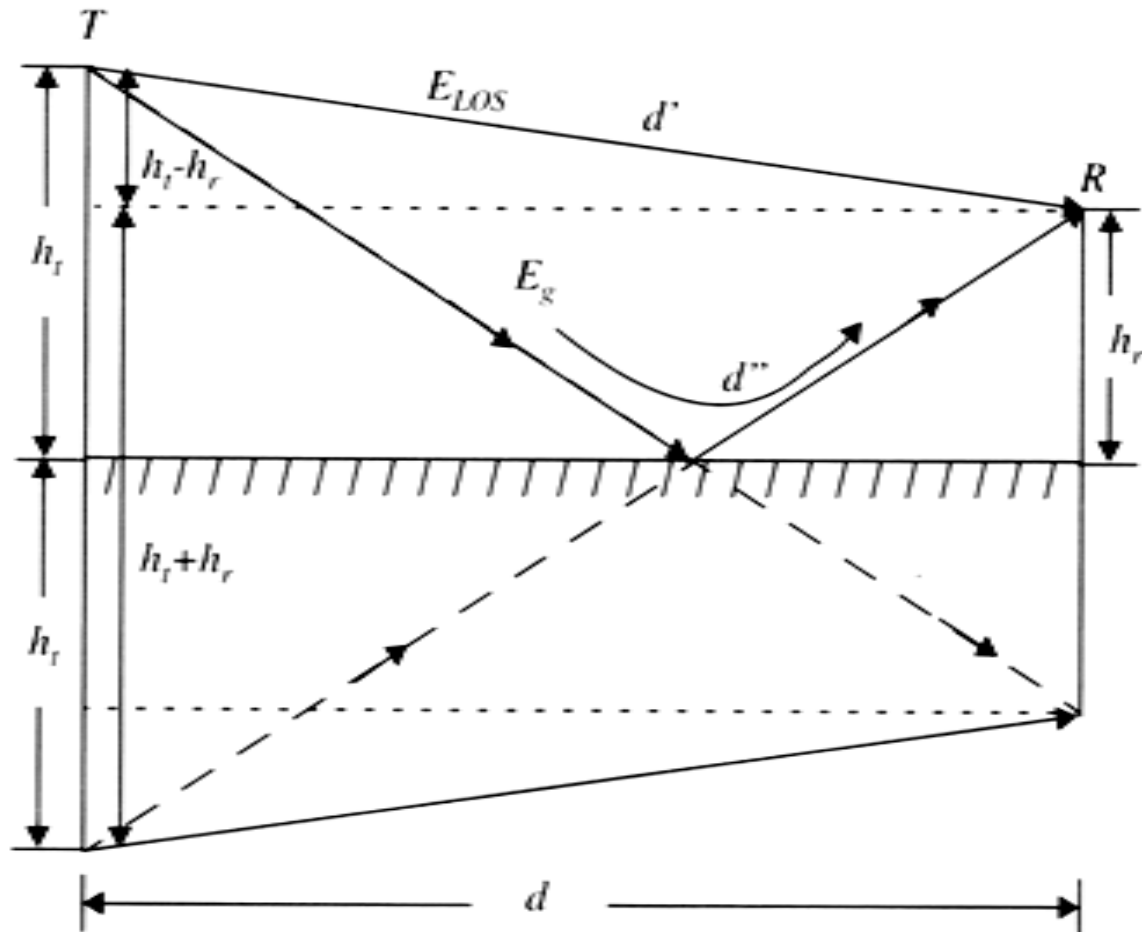

Figure 4.8 The method of images is used to find the path difference between the line-of-sight and the ground reflected paths.

Vector addition of 2 rays

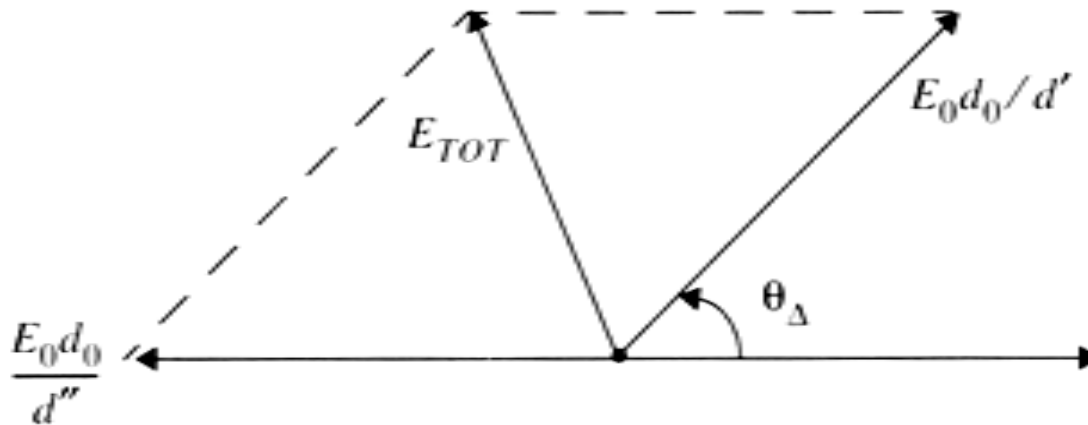

Figure 4.9 Phasor diagram showing the electric field components of the line-of-sight, ground reflected, and total received E-fields, derived from Equation (4.45).

Simplified model

$$P_r = P_t G_t G_r \frac{h_t^2 h_r^2}{d^4}$$

Path loss is due to the decay of the intensity of a propagating radio wave. In the simulations, we use the two-slope path-loss model [32], [33] to obtain the average received power as a function of distance. According to this model, the average path loss is given by

$$G = \frac{K_0}{r^{b_1} \left(1 + \frac{r\lambda_c}{4h_b h_m}\right)^{b_2}} \quad (31)$$

where K_0 is a constant, r is the distance between the mobile user and the base station, $b_1 = 2$ is the basic path-loss exponent, $b_2 = 2$ is the additional path loss component, h_b is the base station antenna height, h_m is the mobile antenna height, and λ_c is the wavelength of the carrier frequency. We assume that the

Diffraction

- Diffraction occurs when waves hit the edge of an obstacle
 - “Secondary” waves propagated into the shadowed region
 - Water wave example
 - Diffraction is caused by the propagation of secondary wavelets into a shadowed region.
 - Excess path length results in a phase shift
 - The field strength of a diffracted wave in the shadowed region is the vector sum of the electric field components of all the secondary wavelets in the space around the obstacle.
 - Huygen’s principle: all points on a wavefront can be considered as point sources for the production of secondary wavelets, and that these wavelets combine to produce a new wavefront in the direction of propagation.

Diffraction geometry

- Fresnel-Kirchoff distraction parameters,

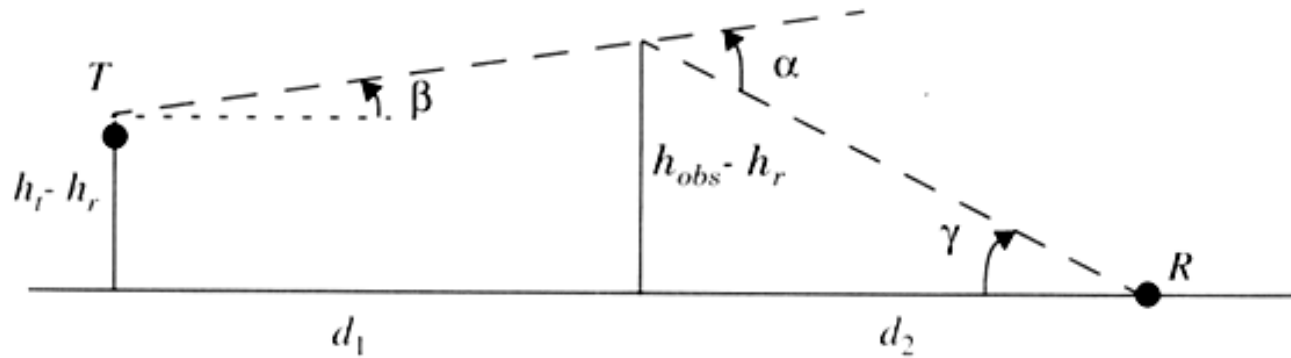

(c) Equivalent knife-edge geometry where the smallest height (in this case h_r) is subtracted from all other heights.

Fresnel Screens

- Fresnel zones relate phase shifts to the positions of obstacles
- A rule of thumb used for line-of-sight

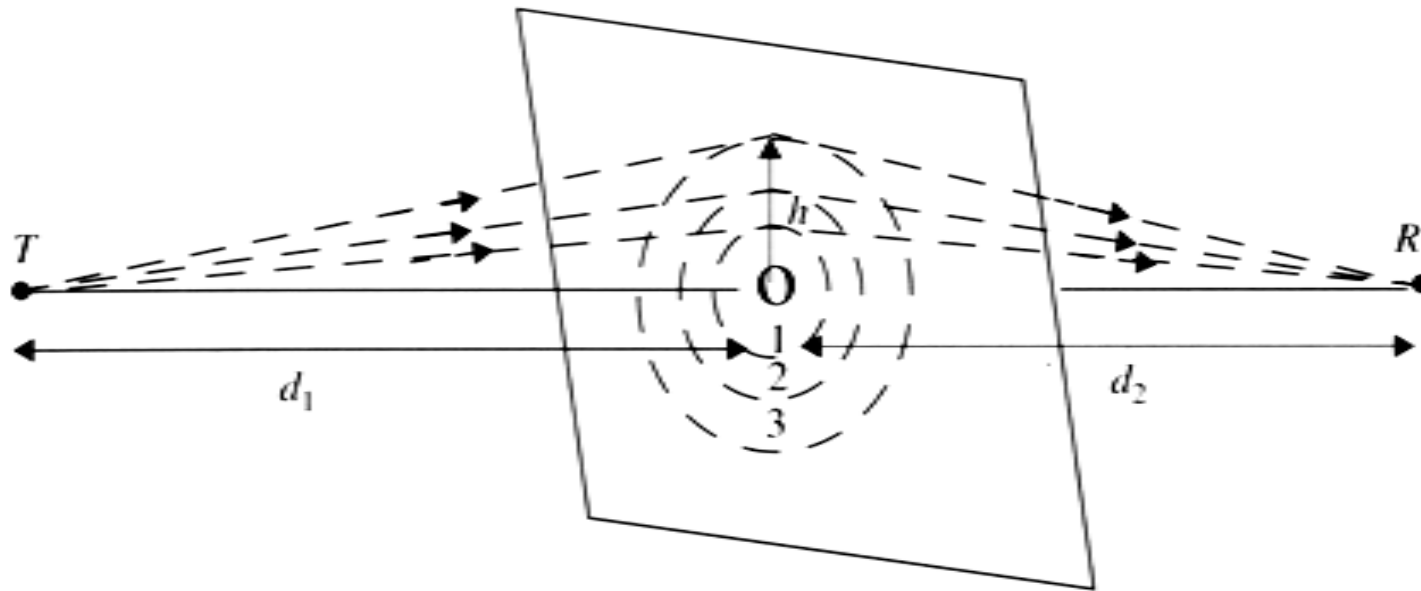

Figure 4.11 Concentric circles which define the boundaries of successive Fresnel zones.

Knife-edge diffraction loss

- Gain

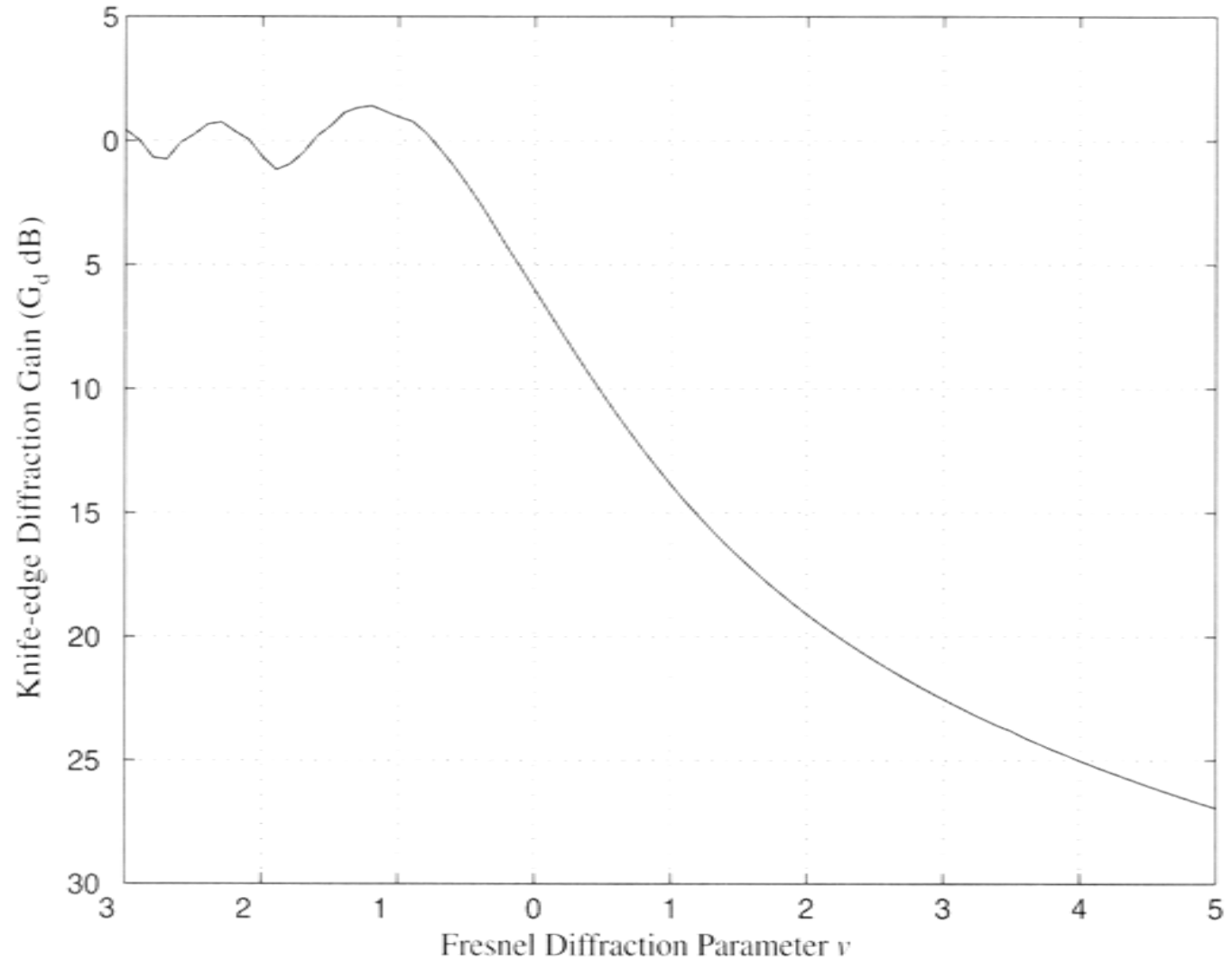

Figure 4.14 Knife-edge diffraction gain as a function of Fresnel diffraction parameter v .

Scattering

- Rough surfaces
 - Lamp posts and trees, scatter all directions
 - [Critical height](#) for bumps is $f(\lambda, \text{incident angle})$,
 - Smooth if its minimum to maximum protuberance h is less than critical height.
 - Scattering loss factor modeled with Gaussian distribution,
- Nearby metal objects (street signs, etc.)
 - Usually modeled statistically
- Large distant objects
 - Analytical model: Radar Cross Section ([RCS](#))
 - Bistatic radar equation,

Impulse Response Model of a Time Variant Multipath Channel

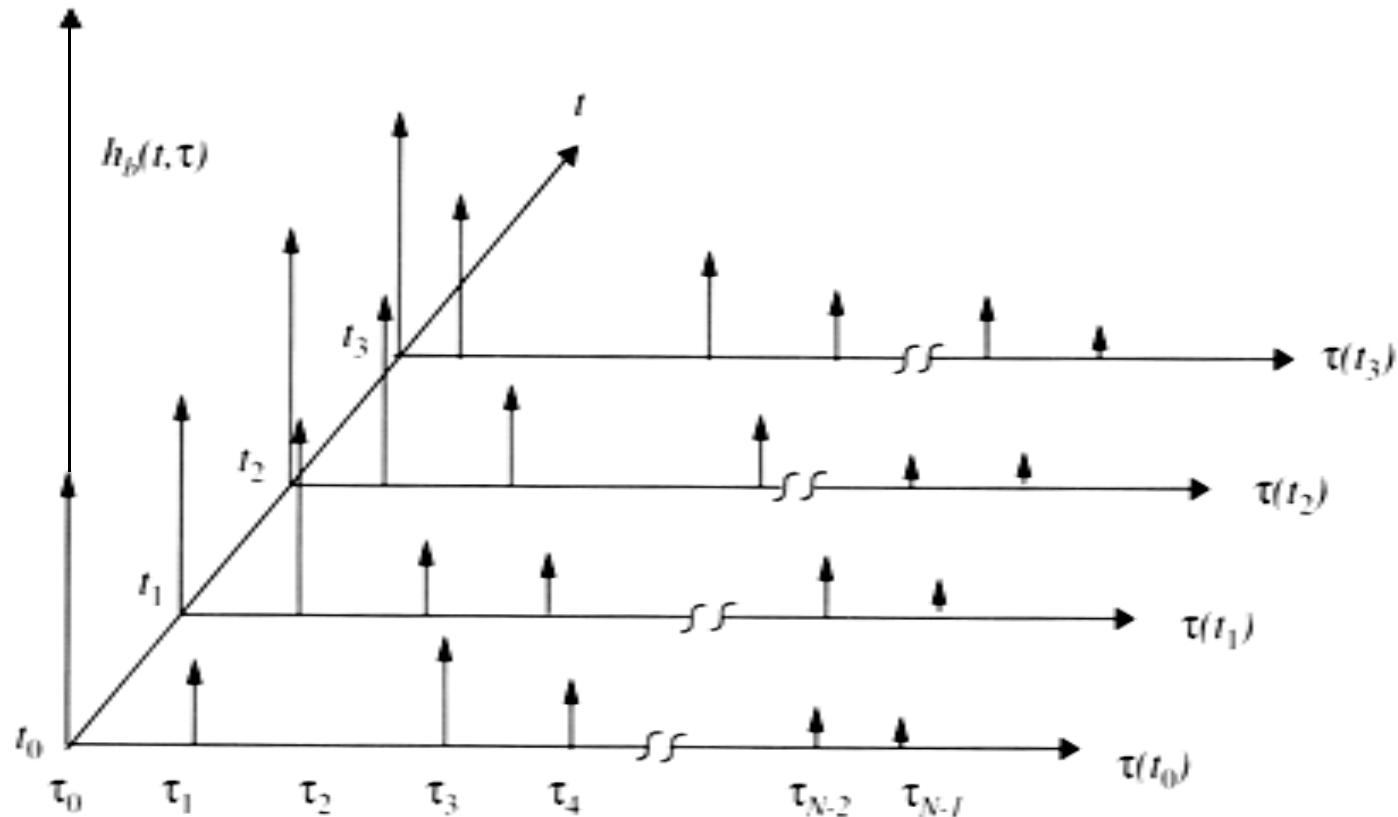

Figure 5.4 An example of the time varying discrete-time impulse response model for a multipath radio channel. Discrete models are useful in simulation where modulation data must be convolved with the channel impulse response [Tra02].

3.2 Free Space Propagation Model

used to predict signal strength for LOS path

- satellites
- LOS *uwave*
- power decay $\propto d^{-n}$ ($d = \text{separation}$)

Subsections

- (1) Friis Equation
- (2) Radiated Power
- (3) Path Loss
- (4) Far Field Region

(1) Friis free space equation: receive power at antenna separated by distance d from transmitter

$$P_r(d) = \left(\frac{G_t G_r \lambda^2}{(4\pi)^2 L} \right) \frac{P_t}{d^2} \quad (3.1)$$

P_r & P_t = received & transmitted power

G_t & G_r = gain of transmit & receive antenna

λ = wavelength

d = separation

L = system losses (line attenuation, filters, antenna)

- not from propagation

- practically, $L \geq 1$, if $L = 1 \rightarrow$ ideal system with no losses

- **power decays** by $d^2 \rightarrow$ decay rate = 20dB/decade

Antenna Gain

$$G = \frac{4\pi}{\lambda^2} A_e \quad (3.2)$$

- A_e = effective area of absorption– related to antenna size

Antenna Efficiency

$$\eta = A_e/A$$

A = antenna's physical area (cross sectional)

- for **parabolic** antenna $\eta \approx 45\% - 50\%$
- for **horn** antenna $\eta \approx 50\% - 80\%$

(2) Radiated Power

Isotropic Radiator: ideal antenna (*used as a reference antenna*)

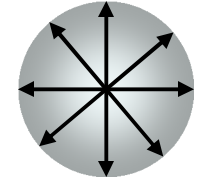

- radiates power with unit gain uniformly in all directions
- **surface area** of a sphere = $4\pi d^2$

Effective Area of isotropic antennae given by $A_{iso} = \frac{\lambda^2}{4\pi}$

Isotropic Received Power $P_R = \left(\frac{\lambda^2}{4\pi} \right) \left(\frac{1}{4\pi d^2} \right) P_T = \frac{\lambda^2}{(4\pi d)^2} P_T$

- d = transmitter-receiver separation

Isotropic free space path loss $L_p = \frac{P_T}{P_R} = \frac{(4\pi d)^2}{\lambda^2}$

- f^2 relationship with antenna size results from dependence of A_{iso} on λ

Directional Radiation

practical antennas have *gain* or *directivity* that is a function of

- ϑ = **azimuth**: look angle of the antenna in the horizontal plane
- ϕ = **elevation**: look angle of the antenna above the horizontal plane

Let Φ = power flux density

transmit antenna gain is given by:

$$G_T(\vartheta, \phi) = \frac{\Phi \text{ in the direction of } (\vartheta, \phi)}{\Phi \text{ of isotropic antenna}}$$

receive antenna gain is given by:

$$G_R(\vartheta, \phi) = \frac{A_e \text{ in the direction of } (\vartheta, \phi)}{A_e \text{ of isotropic antenna}}$$

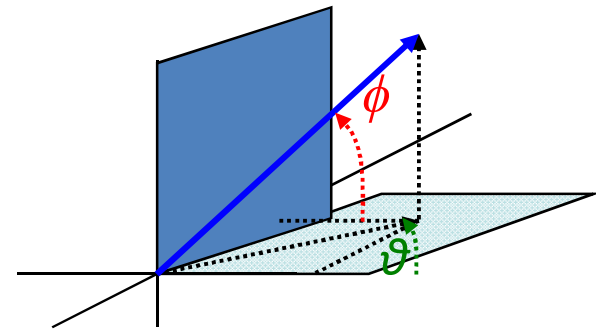

Principal Of Reciprocity:

- signal transmission over a radio path is reciprocal
- the locations of TX & RX can be interchanged without changing transmission characteristics

signals suffers exact same effects over a path in either direction in a consistent order → implies that $G_T(\vartheta, \phi) = G_R(\vartheta, \phi)$

thus **maximum antenna gain** in either direction is given by

$$G = \frac{A_e}{A_{iso}} = \frac{4\pi}{\lambda^2} A_e$$

EIRP: effective isotropic radiated power

- represents maximum radiated power available from a transmitter
- measured in the direction of maximum antenna gain as compared to isotropic radiator

$$\text{EIRP} = P_t G_{iso} \quad (3.4)$$

ERP: effective radiated power - often used in practice

- denotes maximum radiated power compared to $\frac{1}{2}$ wave dipole antenna
- dipole antenna gain = 1.64 (2.15dB) > isotropic antenna
- thus EIRP will be 2.15dB smaller than ERP for same system

$$\text{ERP} = P_t G_{dipole}$$

- 1. Outdoor Propagation Models
 - 1.1 Longley-Rice Model
 - 1.2 Okumura Model
 - 1.3. Hata Model
 - 1.4. PCS Extension to Hata Model
 - 1.5. Walfisch and Bertoni Model

Outdoor Propagation Models

- Propagation over irregular terrain.
- The propagation models available for predicting signal strength vary very widely in their capacity, approach, and accuracy.

Longley-Rice Model

- also referred to as the **ITS** *irregular terrain model*
- frequency range from 40 MHz to 100 GHz
- *Two version:*
- *point-to-point* using terrain profile.
- *area mode* estimate the path-specific parameters

Okumura Model

- Frequency range from 150 MHz to 1920 MHz
- BS-MS distance of 1 km to 100 km.
- BS antenna heights ranging from 30 m to 1000 m.

$$L_{50}(dB) = L_f + A_{mu}(f, d) - G(h_{te}) - G(h_{re}) - G_{AREA}$$

- L_f is the free space propagation loss,
- A_{mu} is the median attenuation relative to free space,
- $G(h_{te})$ is the base station antenna height gain factor, $G(h_{re})$ is the mobile antenna height gain factor,
- G_{AREA} is the gain due to the type of environment.

Hata Model

- Frequency range from 150 MHz to 1500 MHz
- BS-MS distance of 1 km to 100 km.
- BS antenna heights ranging from 30 m to 200 m.

$$L_{50}(\text{urban})(dB) = 69.55 + 26.16 \log f_c - 13.82 \log h_{te} - a(h_{re}) + (44.9 - 6.55 \log h_{te}) \log d$$

- f_c is the frequency (in MHz) from 150 MHz to 1500 MHz,
- h_{te} is the effective transmitter antenna height (in meters)
- h_{re} is the effective receiver (mobile) antenna height (1..10 m)
- d is the **T-R** separation distance (in km),
- $a(h_{re})$ is the correction factor for effective mobile antenna height (large city, small to medium size city, suburban, open rural)

PCS Extension to Hata Model

- Frequency range from 1500 MHz to 2000 MHz
- BS-MS distance of 1 km to 20 km.
- BS antenna heights ranging from 30 m to 200 m.

$$L_{50}(\text{urban}) = 46.3 + 33.9 \log f_c - 13.82 \log h_{te} - a(h_{re}) + (44.9 - 6.55 \log h_{te}) \log d + C_M$$

- f_c is the frequency (in MHz) from 1500 MHz to 2000 MHz,
- h_{te} is the effective transmitter antenna height (in meters)
- h_{re} is the effective receiver (mobile) antenna height (1..10 m)
- d is the **T-R** separation distance (in km),
- $a(h_{re})$ is the correction factor for effective mobile antenna height (large city, small to medium size city, suburban, open rural)
- C_M 0 dB for medium sized city and suburban areas,
- 3 dB for metropolitan centers

Walfisch and Bertoni Model

- considered the impact of the rooftops and building height by using diffraction to predict average signal strength at street level

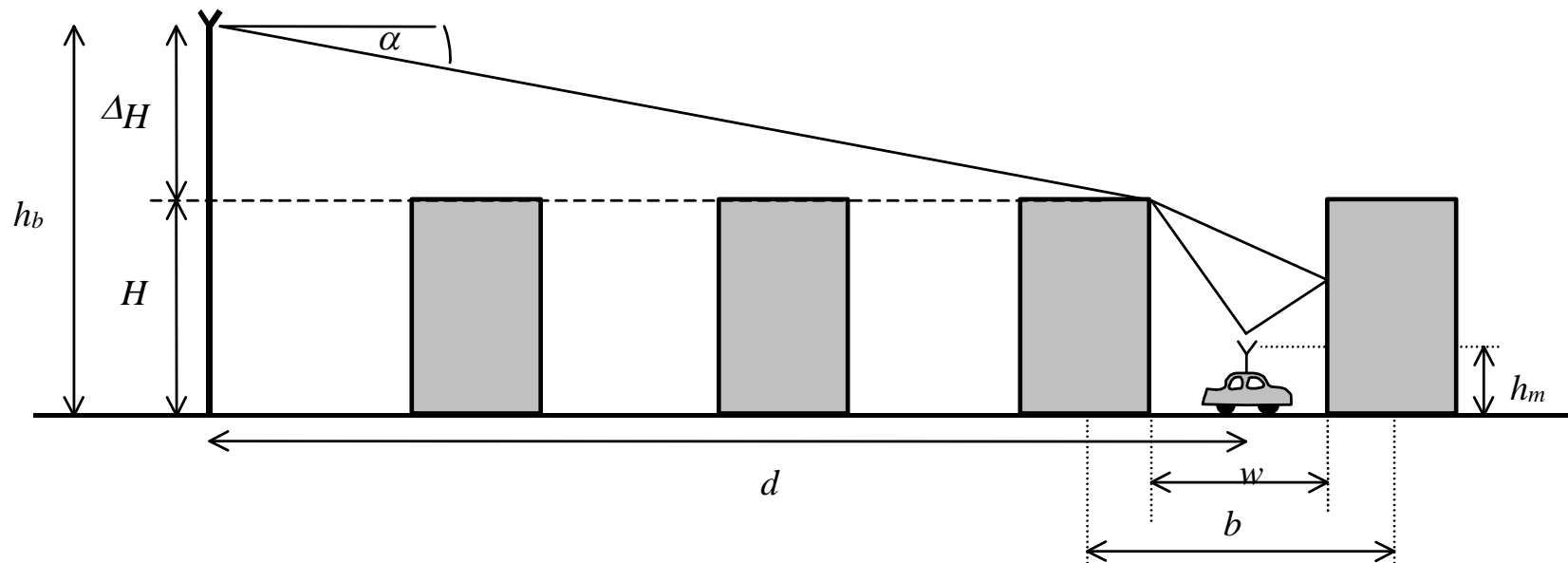

Indoor Propagation Models

- The distances covered are much smaller
- The variability of the environment is much greater
- Key variables: layout of the building, construction materials, building type, where the antenna mounted, ...etc.
- In general, indoor channels may be classified either as LOS or OBS with varying degree of clutter
- The losses between floors of a building are determined by the external dimensions and materials of the building, as well as the type of construction used to create the floors and the external surroundings.
- Floor attenuation factor (FAF)

Partition losses between floors

Table 4.4 Total Floor Attenuation Factor and Standard Deviation σ (dB) for Three Buildings. Each Point Represents the Average Path Loss Over a 20λ Measurement Track [Sei92a]

Building	915 MHz FAF (dB)	σ (dB)	Number of locations	1900 MHz FAF (dB)	σ (dB)	Number of locations
Walnut Creek						
One Floor	33.6	3.2	25	31.3	4.6	110
Two Floors	44.0	4.8	39	38.5	4.0	29
SF PacBell						
One Floor	13.2	9.2	16	26.2	10.5	21
Two Floors	18.1	8.0	10	33.4	9.9	21
Three Floors	24.0	5.6	10	35.2	5.9	20
Four Floors	27.0	6.8	10	38.4	3.4	20
Five Floors	27.1	6.3	10	46.4	3.9	17
San Ramon						
One Floor	29.1	5.8	93	35.4	6.4	74
Two Floors	36.6	6.0	81	35.6	5.9	41
Three Floors	39.6	6.0	70	35.2	3.9	27

Partition losses between floors

Table 4.5 Average Floor Attenuation Factor in dB for One, Two, Three, and Four Floors in Two Office Buildings [Sei92b]

Building	FAF (dB)	σ (dB)	Number of locations
Office Building 1:			
Through One Floor	12.9	7.0	52
Through Two Floors	18.7	2.8	9
Through Three Floors	24.4	1.7	9
Through Four Floors	27.0	1.5	9
Office Building 2:			
Through One Floor	16.2	2.9	21
Through Two Floors	27.5	5.4	21
Through Three Floors	31.6	7.2	21

Log-distance Path Loss Model

- The exponent n depends on the surroundings and building type
 - X_σ is the variable in dB having a standard deviation σ .

Table 4.6 Path Loss Exponent and Standard Deviation Measured in Different Buildings [And94]

Building	Frequency (MHz)	n	σ (dB)
Retail Stores	914	2.2	8.7
Grocery Store	914	1.8	5.2
Office, hard partition	1500	3.0	7.0
Office, soft partition	900	2.4	9.6
Office, soft partition	1900	2.6	14.1
Factory LOS			
Textile/Chemical	1300	2.0	3.0
Textile/Chemical	4000	2.1	7.0
Paper/Cereals	1300	1.8	6.0
Metalworking	1300	1.6	5.8
Suburban Home			
Indoor Street	900	3.0	7.0
Factory OBS			
Textile/Chemical	4000	2.1	9.7
Metalworking	1300	3.3	6.8

$$PL(d) = PL(d_0) + 10n \log(d/d_0) + X_\sigma$$

Ericsson Multiple Breakpoint Model

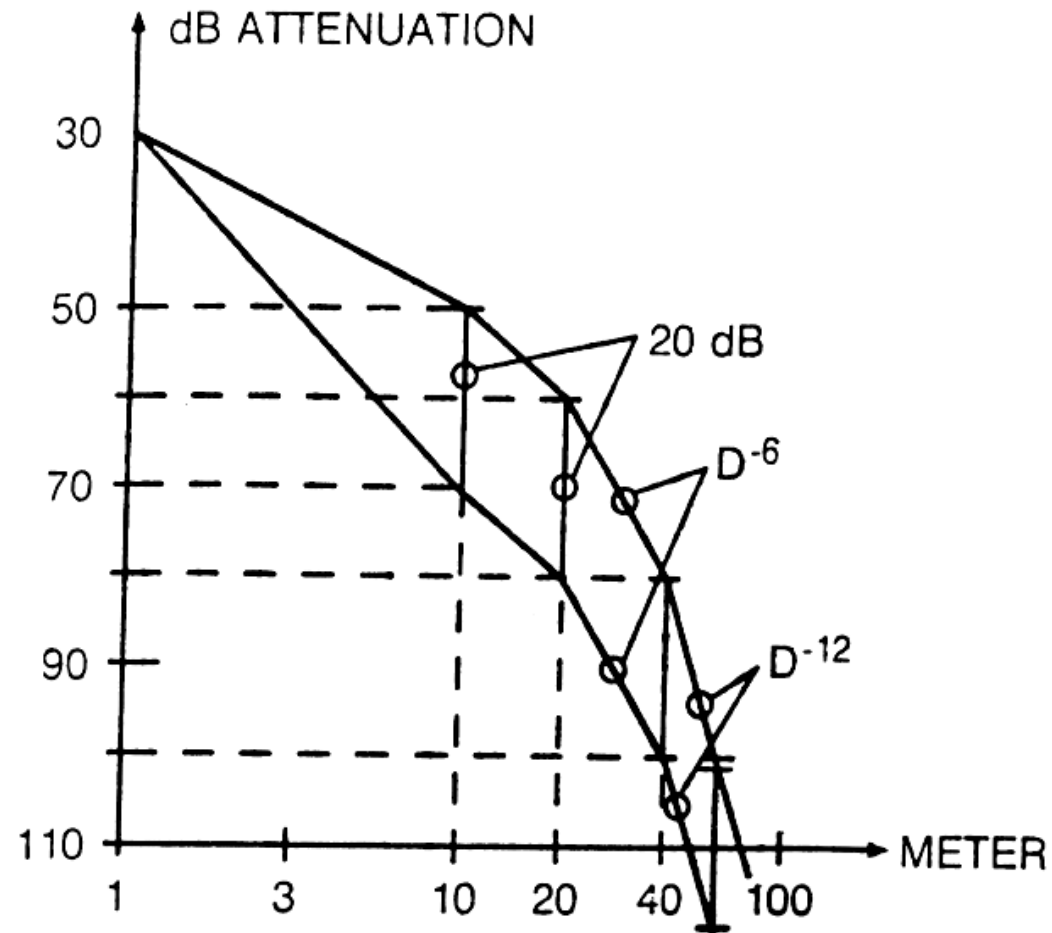

Figure 4.27 Ericsson in-building path loss model [from [Ake88] © IEEE].

Attenuation Factor Model

- FAF represents a floor attenuation factor for a specified number of building floors.

- PAF represents the partition attenuation factor for a specific obstruction encountered by a ray drawn between the transmitter and

$$PL(d) = PL(d_0) + 10n_{SF} \log(d / d_0) + FAF + \sum PAF$$

- α is the attenuation constant for the channel with units of dB⁰ per meter.

$$PL(d) = PL(d_0) + 10 \log(d / d_0) + \alpha d + FAF + \sum PAF$$

Measured indoor path loss

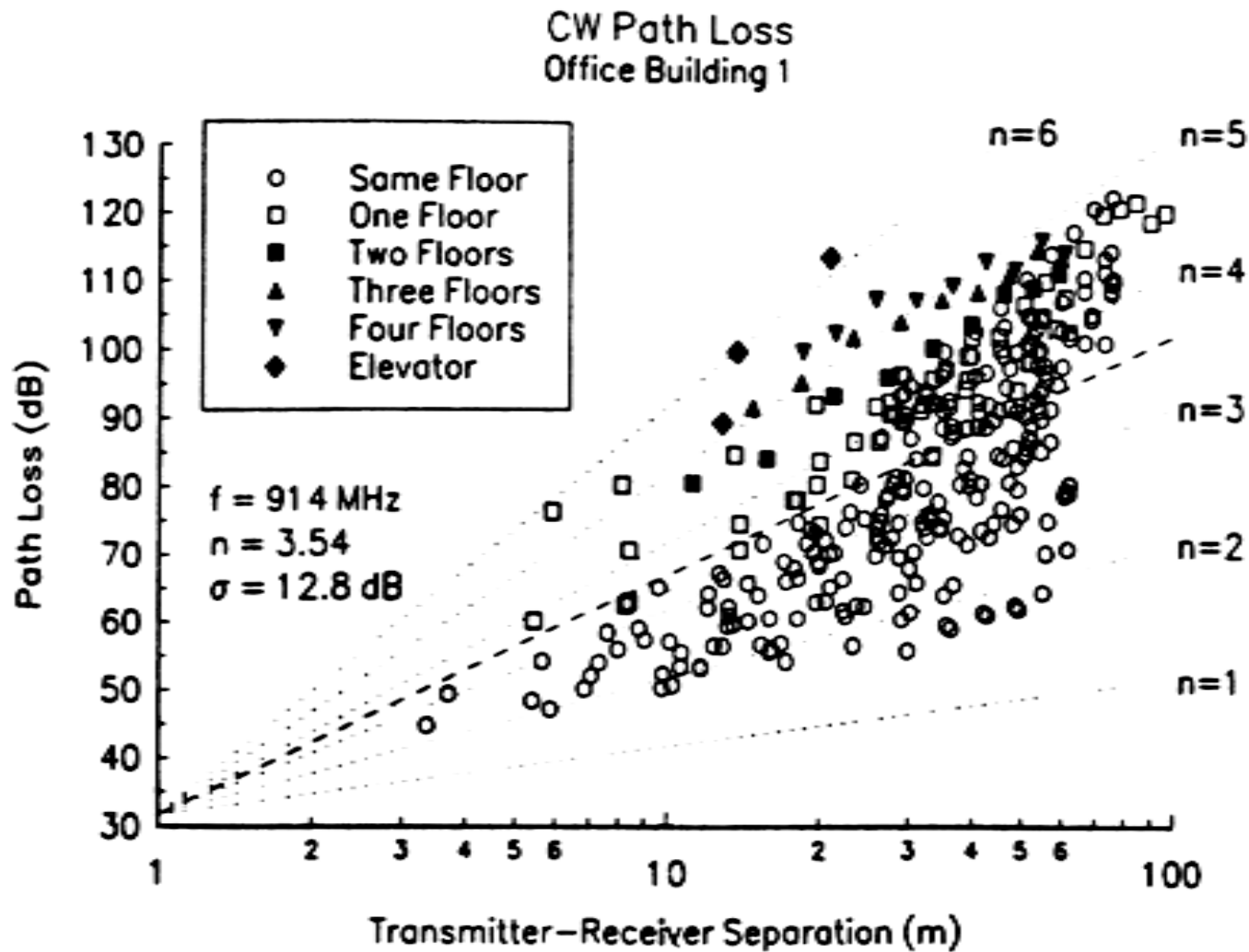

Figure 4.28 Scatter plot of path loss as a function of distance in Office Building 1 [from [Sei92b] © IEEE].

Measured indoor path loss

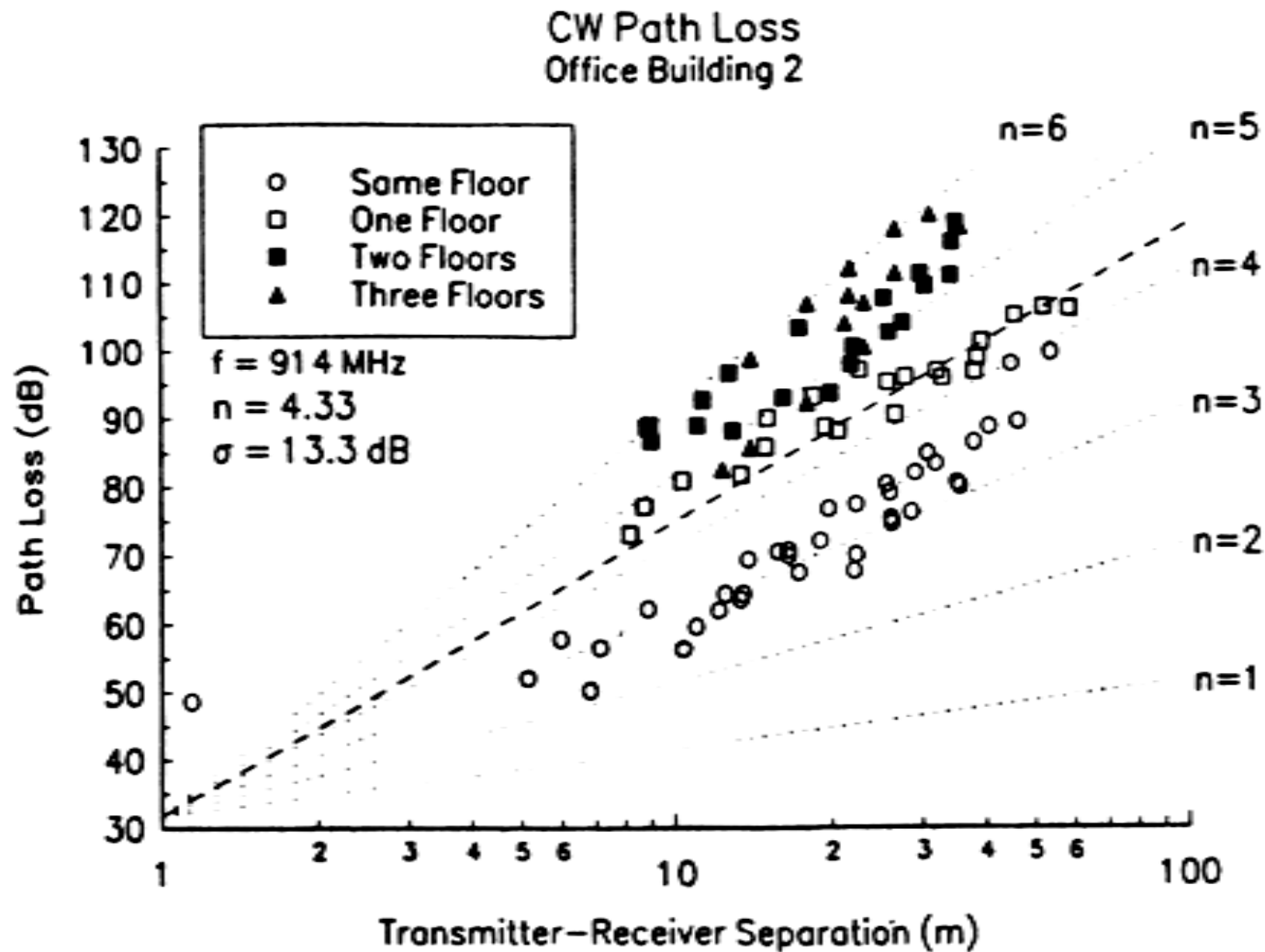

Figure 4.29 Scatter plot of path loss as a function of distance in Office Building 2 [from [Sei92b] © IEEE].

Measured indoor path loss

Table 4.7 Path Loss Exponent and Standard Deviation for Various Types of Buildings [Sei92b]

	n	σ (dB)	Number of locations
All Buildings:			
All locations	3.14	16.3	634
Same Floor	2.76	12.9	501
Through One Floor	4.19	5.1	73
Through Two Floors	5.04	6.5	30
Through Three Floors	5.22	6.7	30
Grocery Store	1.81	5.2	89
Retail Store	2.18	8.7	137
Office Building 1:			
Entire Building	3.54	12.8	320
Same Floor	3.27	11.2	238
West Wing 5th Floor	2.68	8.1	104
Central Wing 5th Floor	4.01	4.3	118
West Wing 4th Floor	3.18	4.4	120
Office Building 2:			
Entire Building	4.33	13.3	100
Same Floor	3.25	5.2	37

Parameters of Mobile Multipath Channels

- Time Dispersion Parameters
 - Grossly quantifies the multipath channel
 - Determined from Power Delay Profile
 - Parameters include
 - Mean Access Delay
 - RMS Delay Spread
 - Excess Delay Spread (X dB)
- Coherence Bandwidth
- Doppler Spread and Coherence Time

Measuring PDPs

- Power Delay Profiles
 - Are measured by channel sounding techniques
 - Plots of relative received power as a function of excess delay
 - They are found by averaging *instantaneous* power delay measurements over a local area
 - Local area: no greater than 6m outdoor
 - Local area: no greater than 2m indoor
 - » Samples taken at $\lambda/4$ meters approximately
 - » For 450MHz – 6 GHz frequency range.

Timer Dispersion Parameters

Determined from a power delay profile.

Mean excess delay ($\bar{\tau}$):

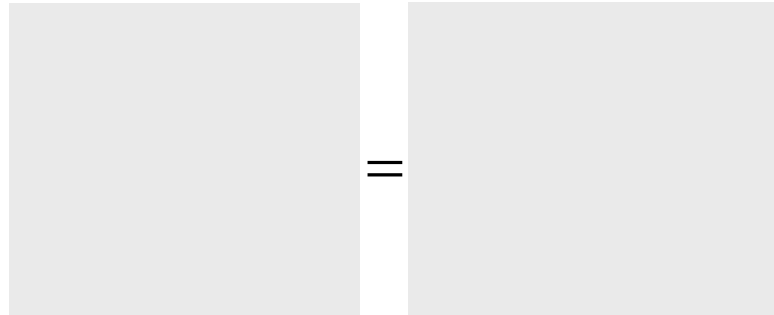

Rms delay spread (σ_τ):

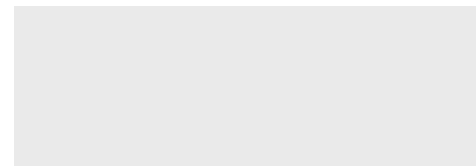

$$\bar{\tau}^2 = \frac{\sum_k a_k^2 \tau_k^2}{\sum_k a_k^2} = \frac{\sum_k P(\tau_k) (\tau_k^2)}{\sum_k P(\tau_k)}$$

RMS Delay Spread

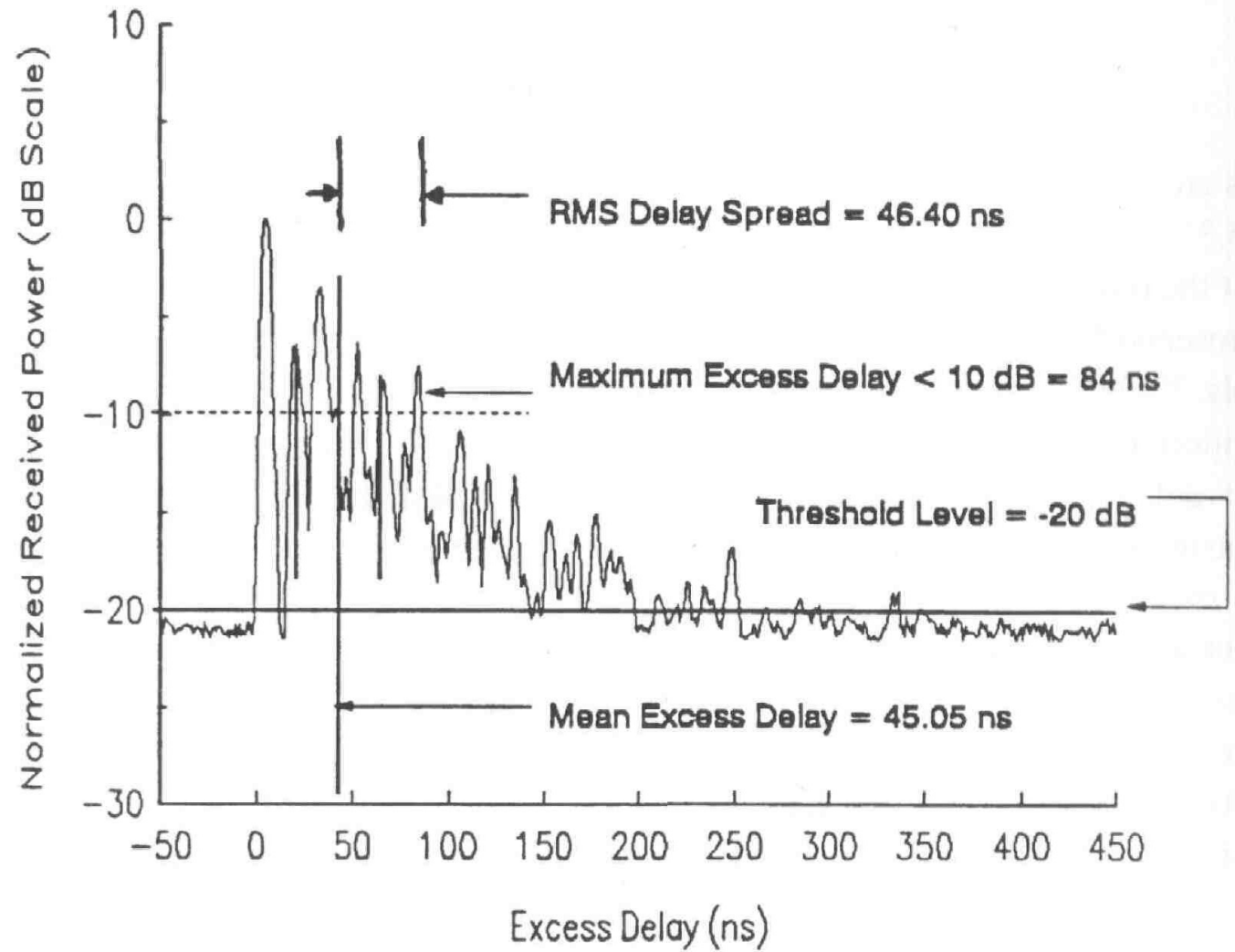

Coherence Bandwidth (B_C)

- Range of frequencies over which the channel can be considered flat (i.e. channel passes all spectral components with equal gain and linear phase).
 - It is a definition that depends on RMS Delay Spread.
- Two sinusoids with frequency separation greater than B_C are affected quite differently by the channel.

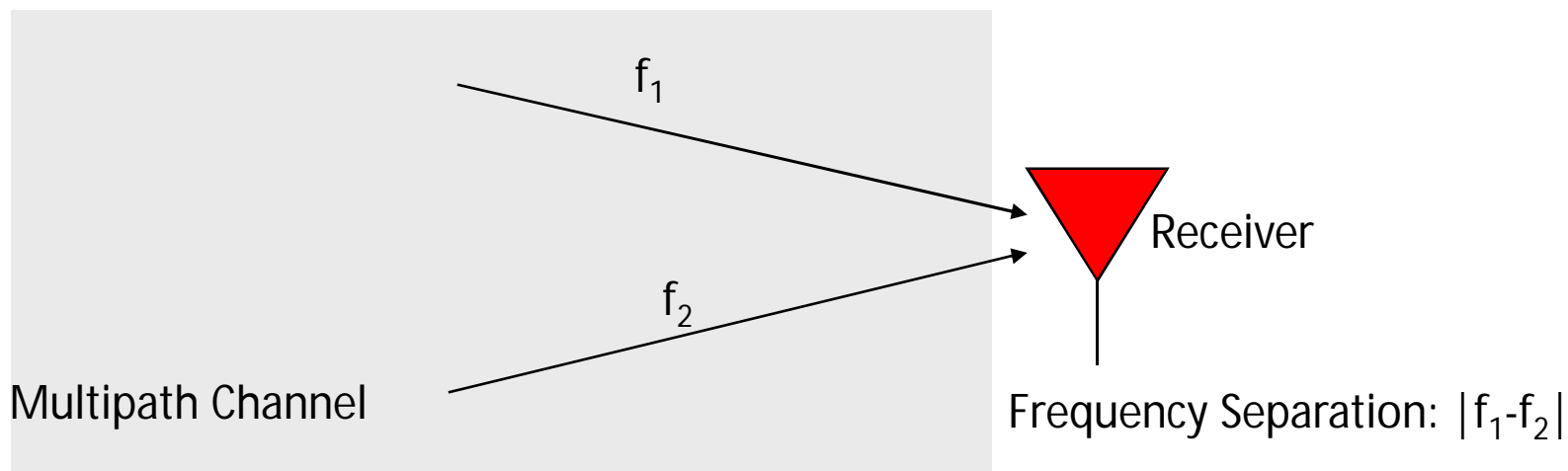

Coherence Bandwidth

Frequency correlation between two sinusoids: $0 \leq C_{r_1, r_2} \leq 1$.

If we define Coherence Bandwidth (B_c) as the range of frequencies over which the frequency correlation is above 0.9, then

$$B_c = \frac{1}{50\sigma} \quad \sigma \text{ is rms delay spread.}$$

If we define Coherence Bandwidth as the range of frequencies over which the frequency correlation is above 0.5, then

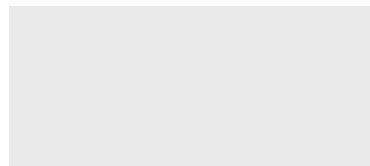

This is called 50% coherence bandwidth.

Coherence Time

- **Delay spread** and **Coherence bandwidth** describe the time dispersive nature of the channel in a local area.
 - They don't offer information about the time varying nature of the channel caused by relative motion of transmitter and receiver.
- **Doppler Spread** and **Coherence time** are parameters which describe the time varying nature of the channel in a small-scale region.

Doppler Spread

- Measure of spectral broadening caused by motion
- We know how to compute Doppler shift: f_d
- Doppler spread, B_D , is defined as the maximum Doppler shift: $f_m = v/\lambda$
- If the baseband signal bandwidth is much greater than B_D then effect of Doppler spread is negligible at the receiver.

Coherence Time

Coherence time is the time duration over which the channel impulse response is essentially invariant.

If the symbol period of the baseband signal (reciprocal of the baseband signal bandwidth) is greater than the coherence time, then the signal will distort, since the channel will change during the transmission of the signal.

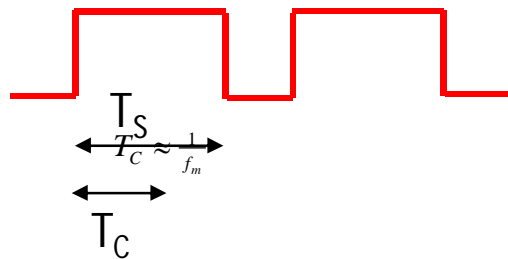

Coherence time (T_C) is defined as:

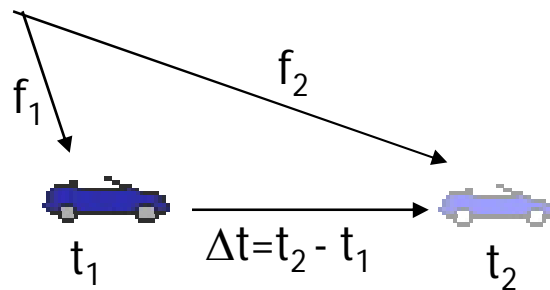

Coherence Time

Coherence time is also defined as:

$$T_c \approx \sqrt{\frac{9}{16\pi f_m^2}} = \frac{0.423}{f_m}$$

Coherence time definition implies that two signals arriving with a time separation greater than T_c are affected differently by the channel.

Types of Fading

Small-scale Fading

(Based on Multipath Time Delay Spread)

Flat Fading

1. BW Signal $<$ BW of Channel
2. Delay Spread $<$ Symbol Period

Frequency Selective Fading

1. BW Signal $>$ Bw of Channel
2. Delay Spread $>$ Symbol Period

Small-scale Fading

(Based on Doppler Spread)

Fast Fading

1. High Doppler Spread
2. Coherence Time $<$ Symbol Period
3. Channel variations faster than baseband signal variations

Slow Fading

1. Low Doppler Spread
2. Coherence Time $>$ Symbol Period
3. Channel variations smaller than signal variations

Flat Fading

- Occurs when the **amplitude of the received signal** changes with time
 - For example according to Rayleigh Distribution
- Occurs when **symbol period** of the transmitted signal is much larger than the Delay Spread of the channel
 - Bandwidth of the applied signal is narrow.
- May cause deep fades.
 - Increase the transmit power to combat this situation.

Flat Fading

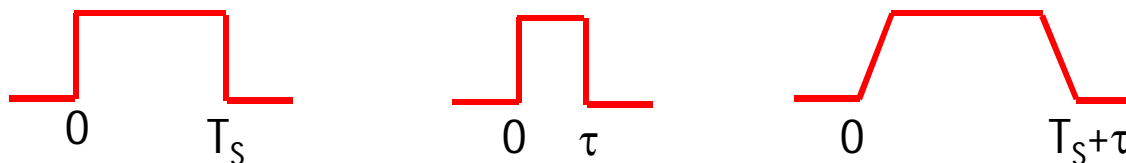
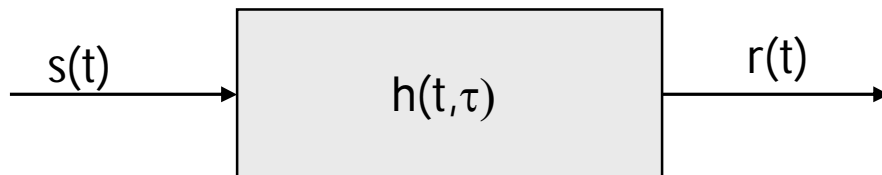

$$\tau \ll T_S$$

Occurs when:

$$B_S \ll B_C$$

and

$$T_S \gg \sigma_\tau$$

B_C : Coherence bandwidth

B_S : Signal bandwidth

T_S : Symbol period

σ_τ : Delay Spread

Frequency Selective Fading

- Occurs when channel multipath delay spread is greater than the symbol period.
 - Symbols face time dispersion
 - Channel induces Intersymbol Interference (ISI)
- Bandwidth of the signal $s(t)$ is wider than the channel impulse response.

Frequency Selective Fading

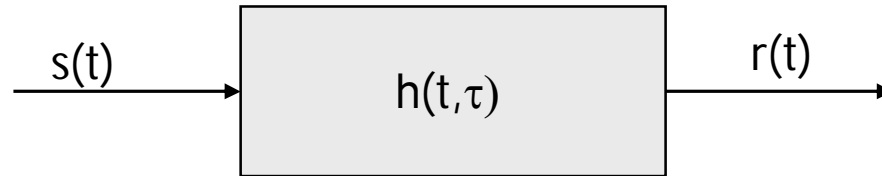

$$\tau \gg T_S$$

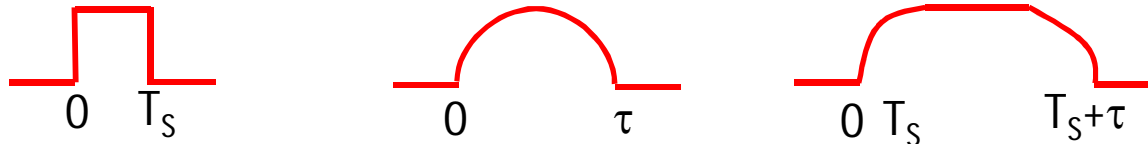

Causes distortion of the received baseband signal

Causes Inter-Symbol Interference (ISI)

Occurs when:

$$B_S > B_C$$

and

$$T_S < \sigma_\tau$$

As a rule of thumb: $T_S < \sigma_\tau$

Fast Fading

- Due to Doppler Spread
 - Rate of change of the channel characteristics is **larger** than the Rate of change of the transmitted signal
 - The channel changes during a symbol period.
 - The channel changes because of receiver motion.
 - Coherence time of the channel is smaller than the symbol period of the transmitter signal

Occurs when:

$$B_S < B_D$$

and

$$T_S > T_C$$

B_S : Bandwidth of the signal

B_D : Doppler Spread

T_S : Symbol Period

T_C : Coherence Bandwidth

Slow Fading

- Due to Doppler Spread
 - Rate of change of the channel characteristics is **much smaller** than the Rate of change of the transmitted signal

Occurs when:

$$B_S \gg B_D$$

and

$$T_S \ll T_C$$

B_S : Bandwidth of the signal

B_D : Doppler Spread

T_S : Symbol Period

T_C : Coherence Bandwidth

Different Types of Fading

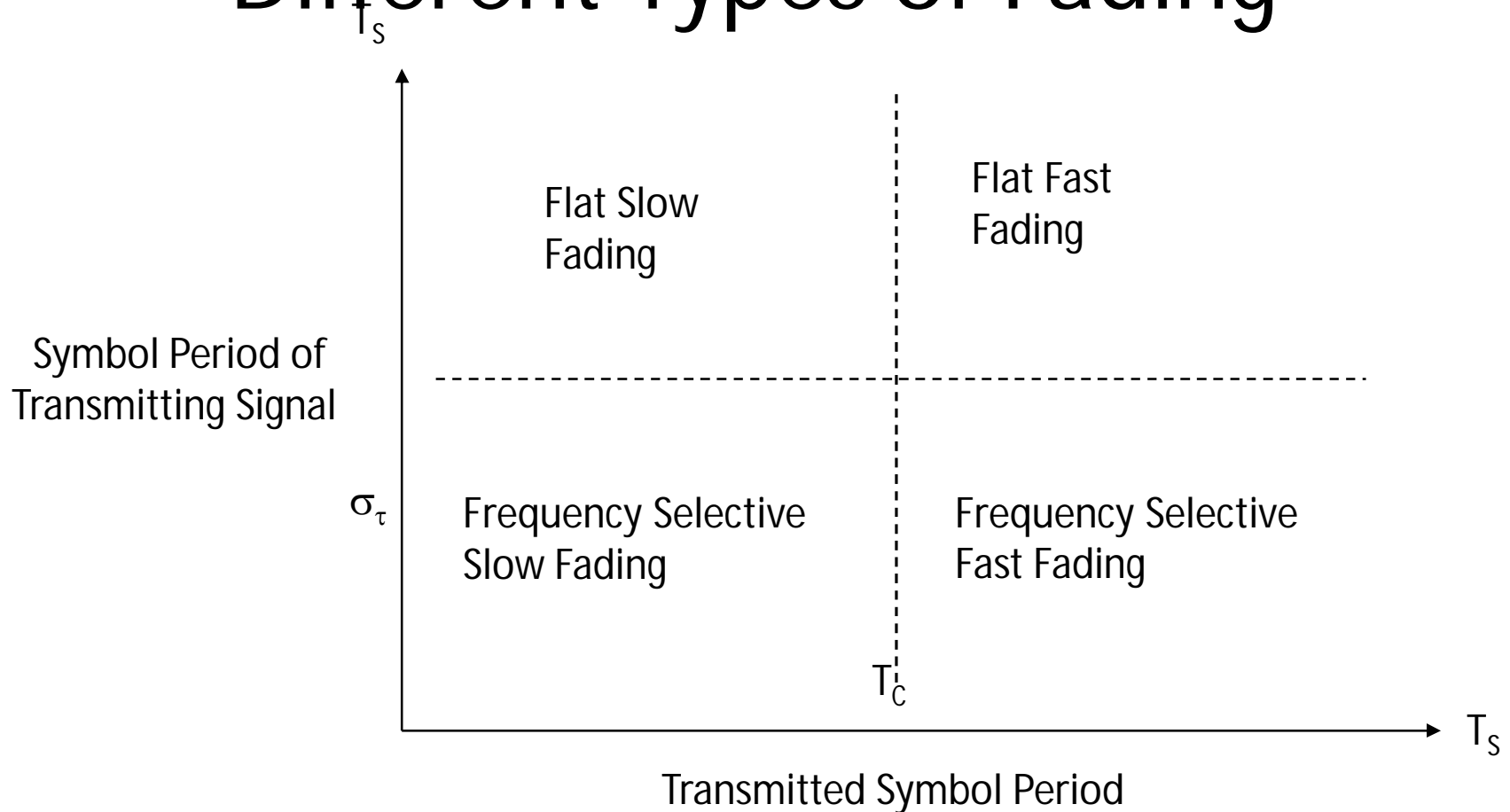

With Respect To SYMBOL PERIOD

Antennas: simple dipoles

- ❖ Real antennas are not isotropic radiators but, e.g., dipoles with lengths $\lambda/4$ on car roofs or $\lambda/2$ as Hertzian dipole
 → shape of antenna proportional to wavelength



- ❖ Example: Radiation pattern of a simple Hertzian dipole

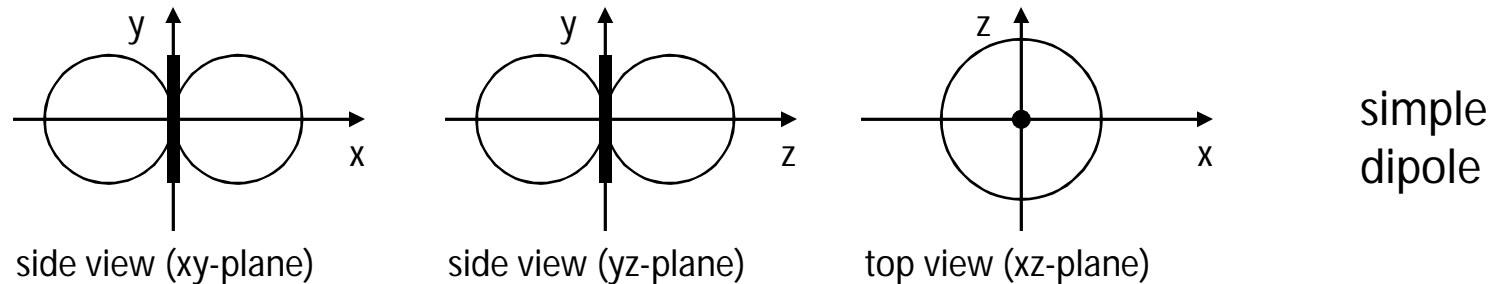

- ❖ Gain: maximum power in the direction of the main lobe compared to the power of an isotropic radiator (with the same average power)

Antennas: Directed and Sectorized

- ❖ Often used for microwave connections or base stations for mobile phones (e.g., radio coverage of a valley)

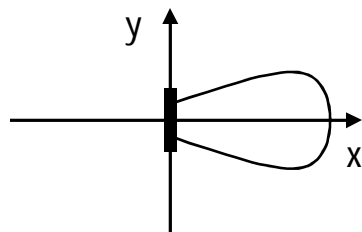

side view (xy-plane)

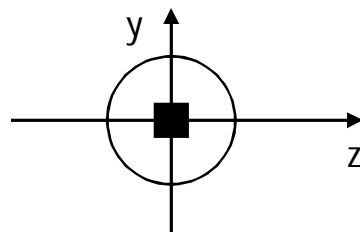

side view (yz-plane)

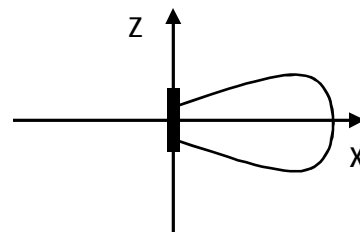

top view (xz-plane)

directed
antenna

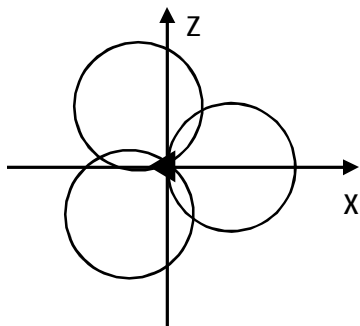

top view, 3 sector

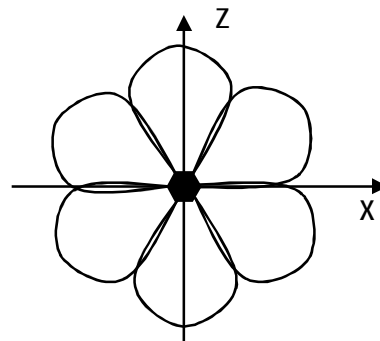

top view, 6 sector

sectorized
antenna

UNIT IV

MODULATION AND SIGNAL PROCESSING

Modulation Techniques

- ❖ Modulation can be done by varying the
 - Amplitude
 - Phase, or
 - Frequency of a high frequency carrier in accordance with the amplitude of the message signal.
- ❖ Demodulation is the inverse operation: extracting the baseband message from the carrier so that it may be processed at the receiver.

Analog/Digital Modulation

❖ Analog Modulation

- The input is continuous signal
- Used in first generation mobile radio systems such as AMPS in USA.

❖ Digital Modulation

- The input is time sequence of symbols or pulses.
- Are used in current and future mobile radio systems

Goal of Modulation Techniques

- ❖ Modulation is difficult task given the hostile mobile radio channels
 - Small-scale fading and multipath conditions.
- ❖ The goal of a modulation scheme is:
 - Transport the message signal through the radio channel with best possible quality
 - Occupy least amount of radio (RF) spectrum.

Amplitude Modulation

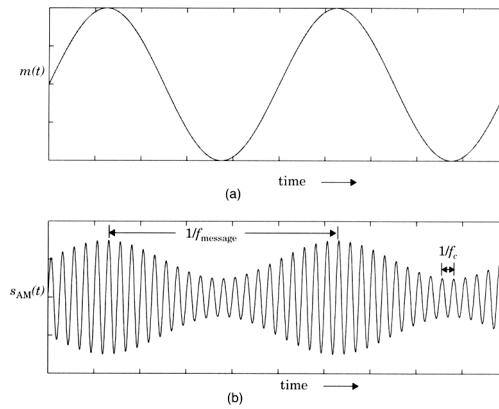

Figure 6.1 (a) A sinusoidal modulating signal and (b) the corresponding AM signal with modulation index 0.5.

Double Sideband Spectrum

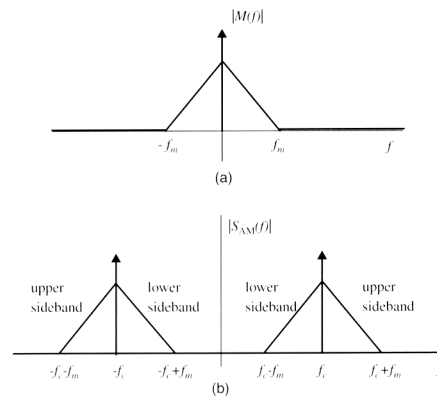

Figure 6.2 (a) Spectrum of a message signal; (b) spectrum of the corresponding AM signal.

SSB Modulators

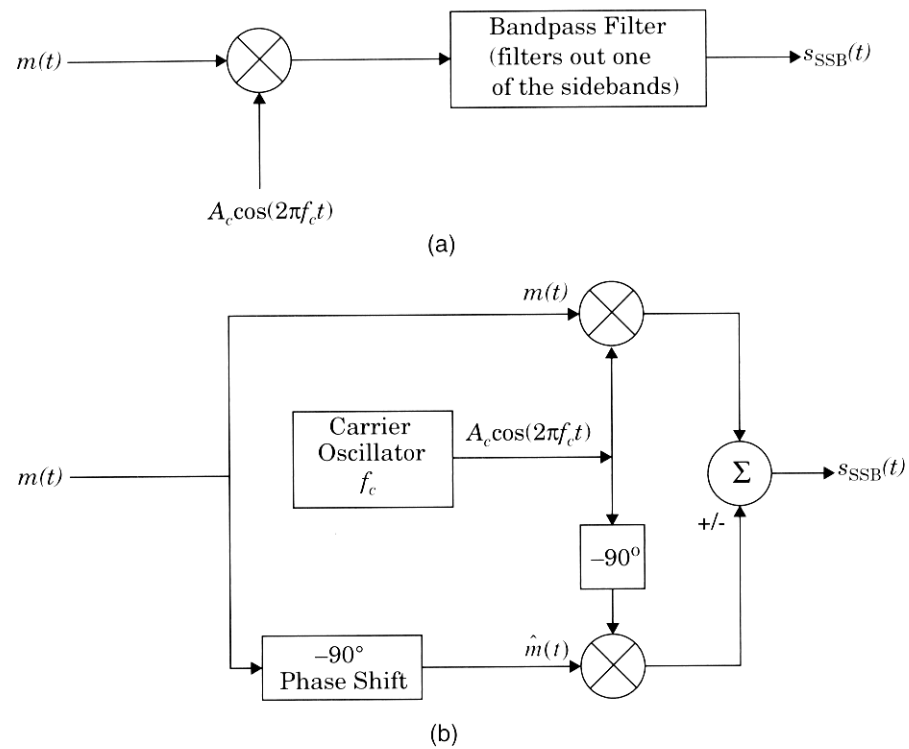

Figure 6.3 Generation of SSB using (a) a sideband filter and (b) a balanced modulator.

Wideband FM generation

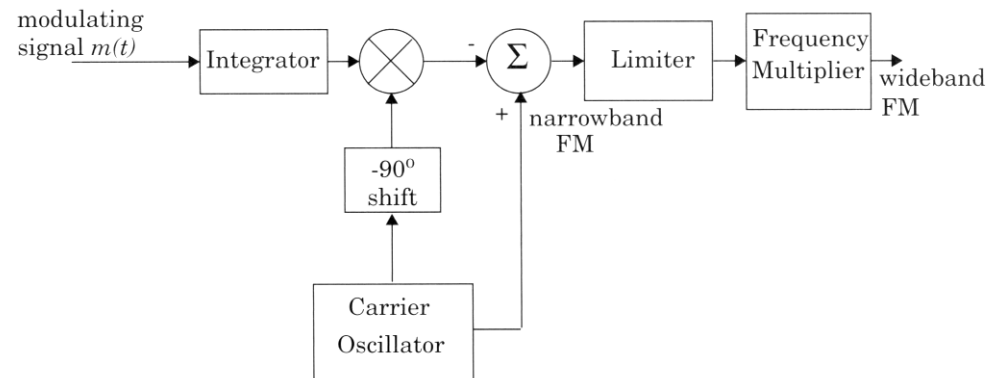

Figure 6.7 Indirect method for generating a wideband FM signal. A narrowband FM signal is generated using a balanced modulator and then frequency multiplied to generate a wideband FM signal.

Slope Detector for FM

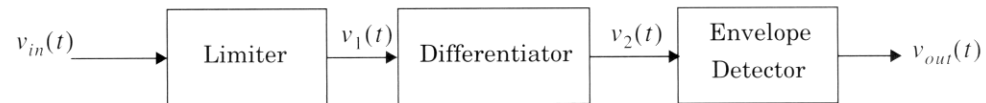

Figure 6.8 Block diagram of a slope detector type FM demodulator.

Digital Modulation

- ❖ The input is discrete signals
 - Time sequence of pulses or symbols
- ❖ Offers many advantages
 - Robustness to channel impairments
 - Easier multiplexing of various sources of information: voice, data, video.
 - Can accommodate digital error-control codes
 - Enables encryption of the transferred signals
 - More secure link

Factors that Influence Choice of Digital Modulation Techniques

- ❖ A desired modulation scheme
 - Provides low bit-error rates at low SNRs
 - Power efficiency
 - Performs well in multipath and fading conditions
 - Occupies minimum RF channel bandwidth
 - Bandwidth efficiency
 - Is easy and cost-effective to implement
- ❖ Depending on the demands of a particular system or application, tradeoffs are made when selecting a digital modulation scheme.

Power Efficiency of Modulation

- ❖ Power efficiency is the ability of the modulation technique to preserve fidelity of the message at low power levels.
- ❖ Usually in order to obtain good fidelity, the signal power needs to be increased.
 - Tradeoff between fidelity and signal power
 - Power efficiency describes how efficient this tradeoff is made

- ❖ E_b : signal energy per bit
- ❖ N_0 : noise power spectral density
- ❖ PER: probability of error

Bandwidth Efficiency of Modulation

- ❖ Ability of a modulation scheme to accommodate data within a limited bandwidth.
- ❖ Bandwidth efficiency reflect how efficiently the allocated bandwidth is utilized

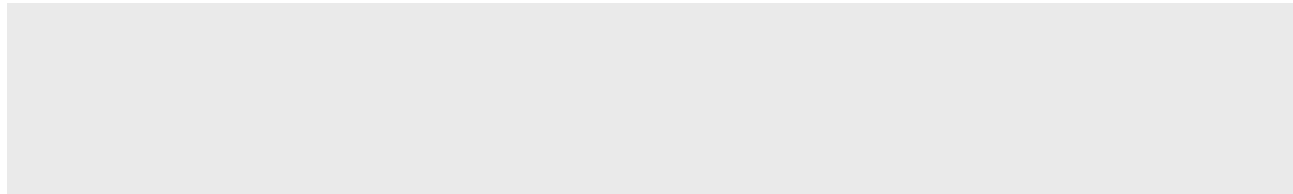

R: the data rate (bps)

B: bandwidth occupied by the modulated RF signal

Linear Modulation Techniques

❖ Classify digital modulation techniques as:

➤ Linear

- The amplitude of the transmitted signal varies linearly with the modulating digital signal, $m(t)$.
- They usually do not have constant envelope.
- More spectral efficient.
- Poor power efficiency
- Example: QPSK.

➤ Non-linear

Binary Phase Shift Keying

- ❖ Use alternative sine wave phase to encode bits
 - Phases are separated by 180 degrees.
 - Simple to implement, inefficient use of bandwidth.
 - Very robust, used extensively in satellite communication.

$$s_1(t) = A_c \cos(2\pi f_c t + \theta_c) \quad \text{binary 1}$$

$$s_2(t) = A_c \cos(2\pi f_c t + \theta_c + \pi) \quad \text{binary 0}$$

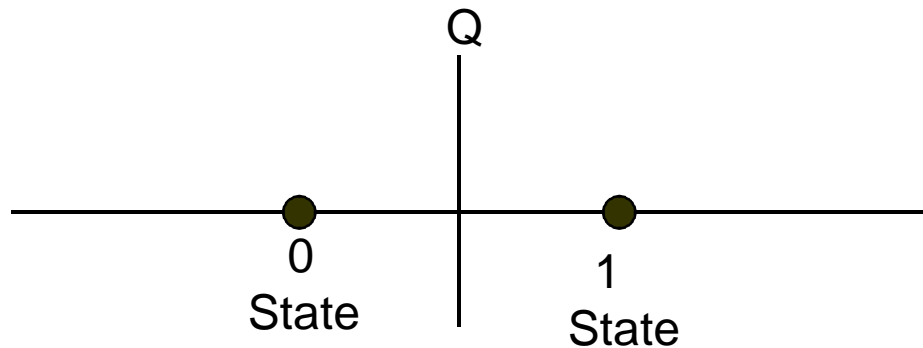

BPSK Example

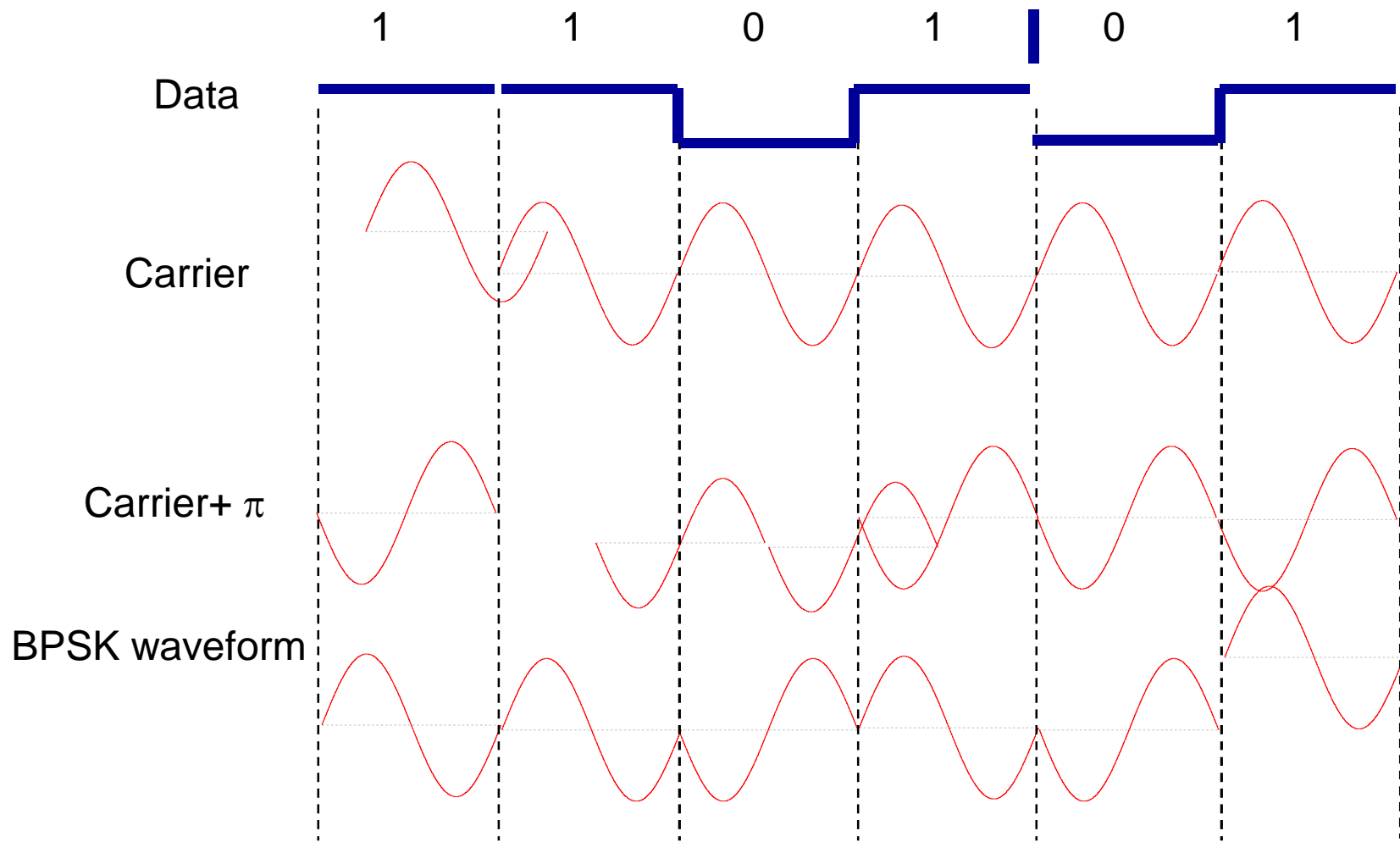

Quadrature Phase Shift Keying

- ❖ Multilevel Modulation Technique: 2 bits per symbol
- ❖ More spectrally efficient, more complex receiver.
- ❖ Two times more bandwidth efficient than BPSK

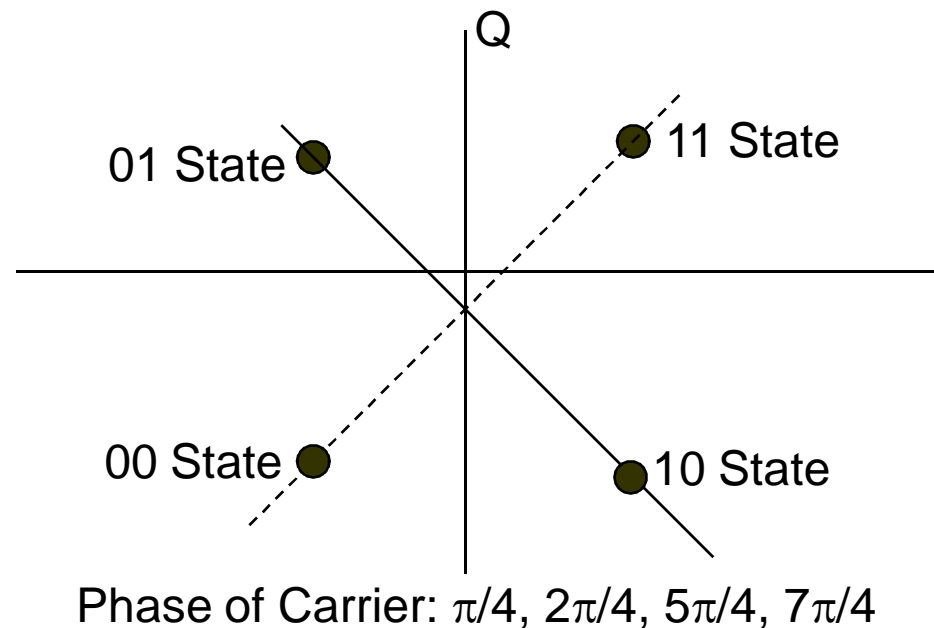

4 different waveforms

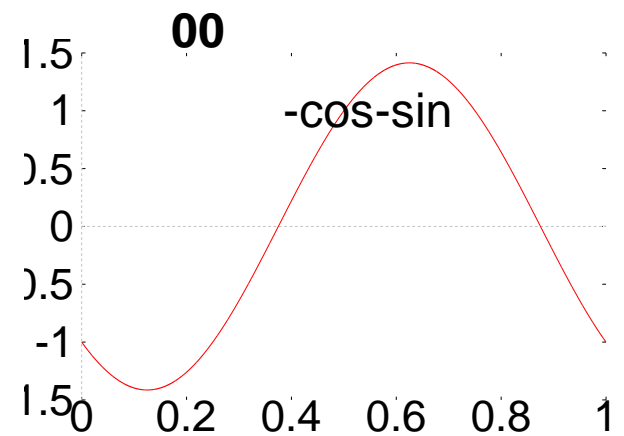
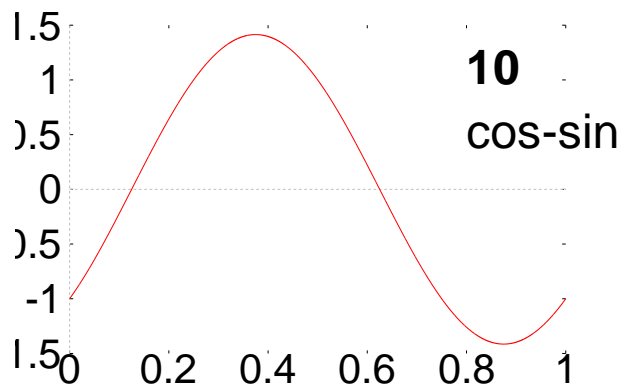
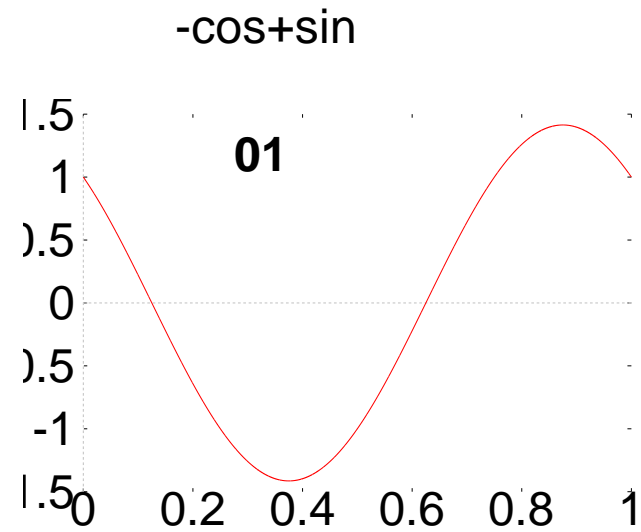
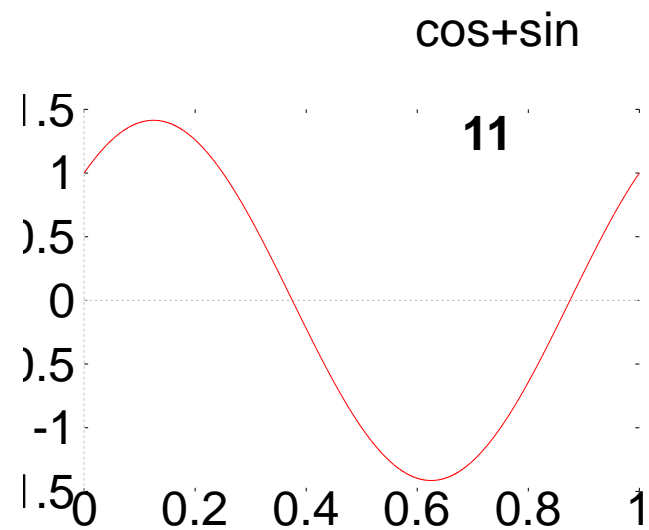

Constant Envelope Modulation

- ❖ Amplitude of the carrier is constant, regardless of the variation in the modulating signal
 - Better immunity to fluctuations due to fading.
 - Better random noise immunity
 - Power efficient
- ❖ They occupy larger bandwidth

Frequency Shift Keying (FSK)

- ❖ The frequency of the carrier is changed according to the message state (high (1) or low (0)).

$$s_1(t) = A \cos(2\pi f_c + 2\pi\Delta f)t \quad 0 \leq t \leq T_b \text{ (bit = 1)}$$

$$s_2(t) = A \cos(2\pi f_c - 2\pi\Delta f)t \quad 0 \leq t \leq T_b \text{ (bit = 0)}$$

Continues FSK

$$s(t) = A \cos(2\pi f_c t + \theta(t))$$

$$s(t) = A \cos(2\pi f_c t + 2\pi k_f \int_{-\infty}^t m(x) dx)$$

Integral of $m(x)$ is continues.

FSK Example

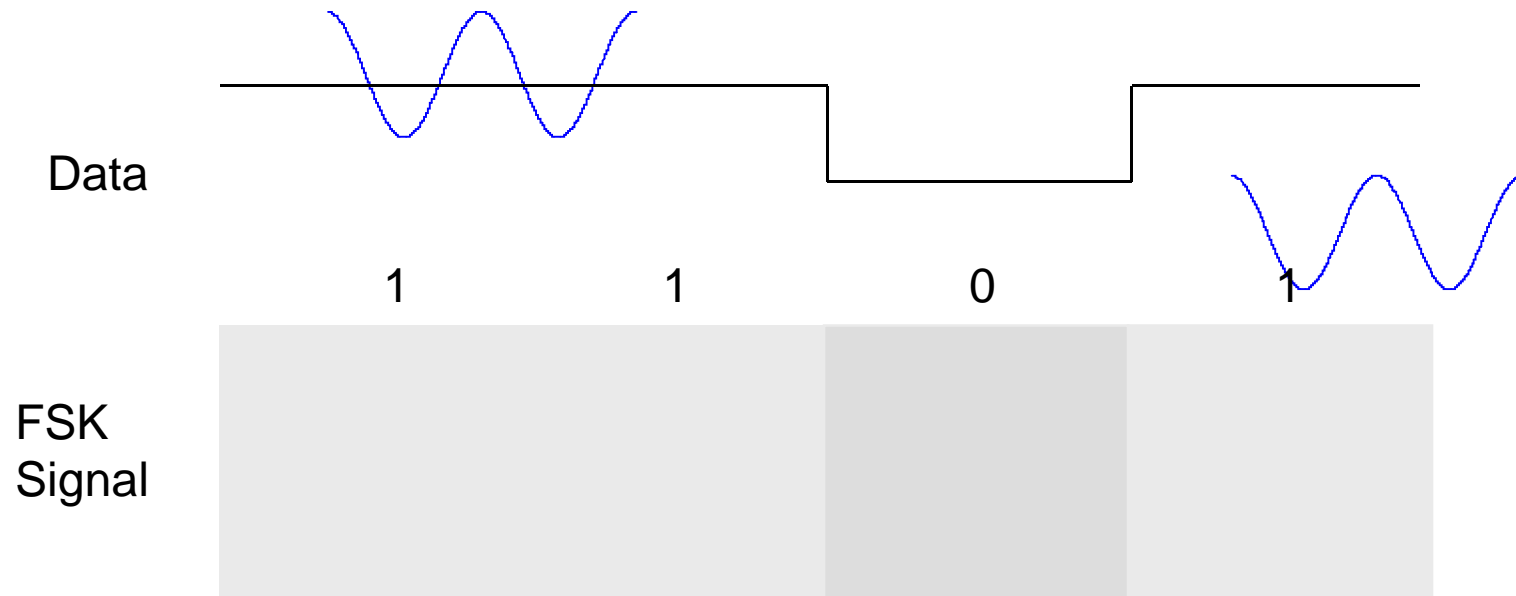

BPSK constellation

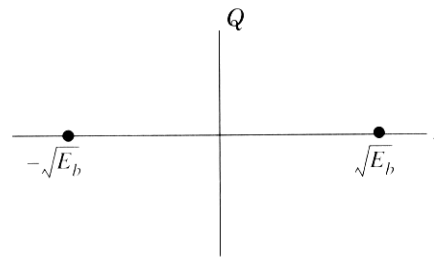

Figure 6.21 BPSK constellation diagram.

Virtue of pulse shaping

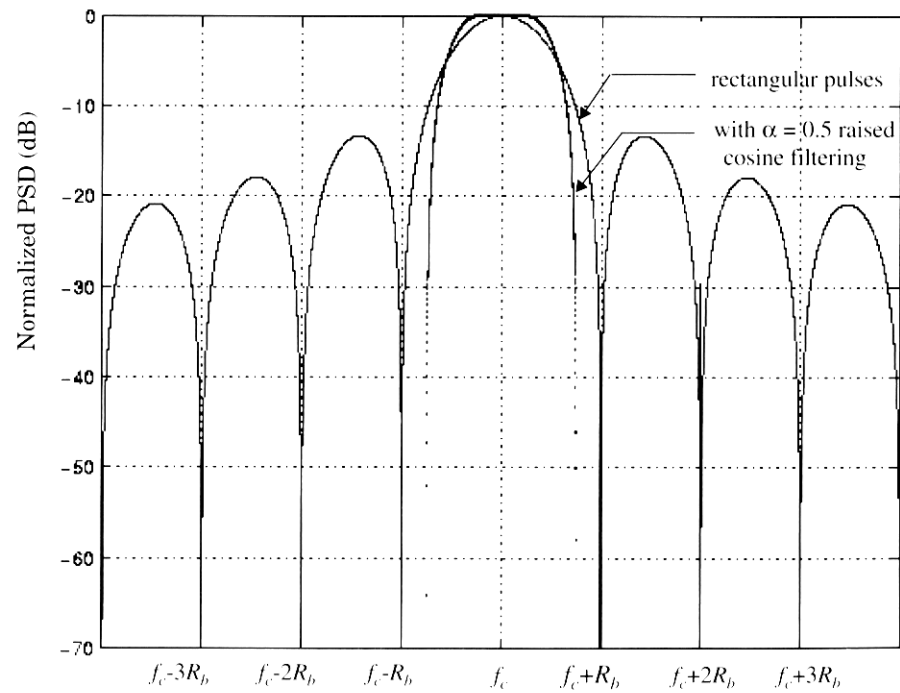

Figure 6.22 Power spectral density (PSD) of a BPSK signal.

BPSK Coherent demodulator

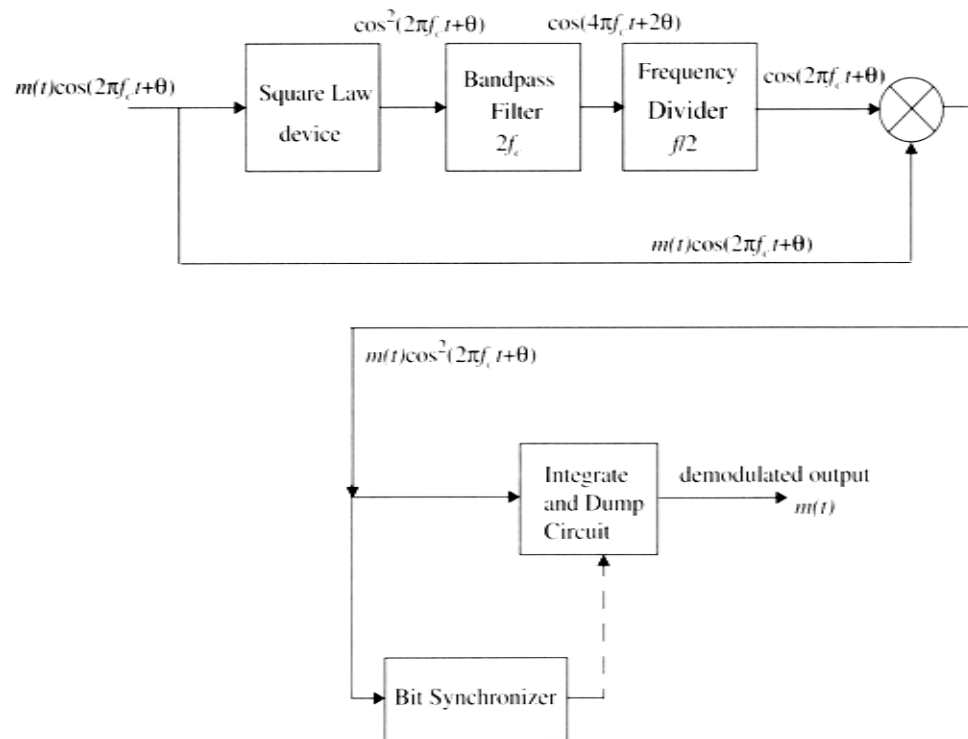

Figure 6.23 BPSK receiver with carrier recovery circuits.

Equalization, Diversity and Channel coding

- Three techniques are used to improve Rx signal quality and lower BER:
 - 1) Equalization
 - 2) Diversity
 - 3) Channel Coding
 - Used independently or together
 - We will consider Diversity and Channel Coding

III. Diversity Techniques

- Diversity : Primary goal is to reduce depth & duration of small-scale fades
 - Spatial or antenna diversity → most common
 - Use **multiple** Rx antennas in mobile or base station
 - Why would this be helpful?
 - Even small antenna separation ($\propto \lambda$) changes phase of signal → constructive /destructive nature is changed
 - Other diversity types → polarization, frequency, & time

- Exploits random behavior of MRC
 - Goal is to make use of several independent (uncorrelated) received signal paths
 - Why is this necessary?
- **Select** path with best *SNR* or **combine** multiple paths → improve overall *SNR* performance

- Microscopic diversity → combat **small-scale** fading
 - Most widely used
 - Use multiple antennas separated in space
 - At a **mobile**, signals are independent if separation $> \lambda / 2$
 - But it is not practical to have a mobile with multiple antennas separated by $\lambda / 2$ (7.5 cm apart at 2 GHz)
 - Can have multiple receiving antennas at base stations, but must be separated on the order of ten wavelengths (1 to 5 meters).

- Since reflections occur near receiver, independent signals spread out a lot before they reach the base station.
- a typical antenna configuration for 120 degree sectoring.
- For each sector, a transmit antenna is in the center, with two diversity receiving antennas on each side.
- If one radio path undergoes a deep fade, another independent path may have a strong signal.
- By having more than one path one select from, both the instantaneous and average SNRs at the receiver may be improved

- **Spatial** or Antenna Diversity → 4 basic types
 - M independent branches
 - Variable gain & phase at each branch → $G \angle \theta$
 - Each branch has same average SNR:

$$SNR = \Gamma = \frac{E_b}{N_0}$$

- Instantaneous $SNR = \gamma_i$ the pdf of γ_i

$$p(\gamma_i) = \frac{1}{\Gamma} e^{-\frac{\gamma_i}{\Gamma}} \quad \gamma_i \geq 0 \quad (6.155)$$

$$\Pr[\gamma_i \leq \gamma] = \int_0^{\gamma} p(\gamma_i) d\gamma_i = \int_0^{\gamma} \frac{1}{\Gamma} e^{-\frac{\gamma_i}{\Gamma}} d\gamma_i = 1 - e^{-\frac{\gamma}{\Gamma}}$$

- The probability that all M independent diversity branches Rx signal which are simultaneously less than some specific SNR threshold γ

$$\Pr[\gamma_1, \dots, \gamma_M \leq \gamma] = (1 - e^{-\gamma/\Gamma})^M = P_M(\gamma)$$

$$\Pr[\gamma_i > \gamma] = 1 - P_M(\gamma) = 1 - (1 - e^{-\gamma/\Gamma})^M$$

- The pdf of γ $p_M(\gamma) = \frac{d}{d\gamma} P_M(\gamma) = \frac{M}{\Gamma} (1 - e^{-\gamma/\Gamma})^{M-1} e^{-\gamma/\Gamma}$

- Average SNR improvement offered by selection diversity

$$\bar{\gamma} = \int_0^{\infty} \gamma p_M(\gamma) d\gamma = \Gamma \int_0^{\infty} Mx (1 - e^{-x})^{M-1} e^{-x} dx, \quad x = \gamma/\Gamma$$

$$\frac{\bar{\gamma}}{\Gamma} = \sum_{k=1}^M \frac{1}{k}$$

1) Selection Diversity → simple & cheap

- Rx selects branch with highest **instantaneous SNR**
 - new selection made at a time that is the reciprocal of the fading rate
 - this will cause the system to stay with the current signal until it is likely the signal has faded
- SNR improvement :
 - $\bar{\gamma}$ is new avg. SNR
 - Γ : avg. SNR in each branch

$$\bar{\gamma} = \Gamma \sum_{k=1}^m \frac{1}{k} = \Gamma \left(1 + \frac{1}{2} + \frac{1}{3} + \frac{1}{4} + \cdots + \frac{1}{m} \right) > \Gamma$$

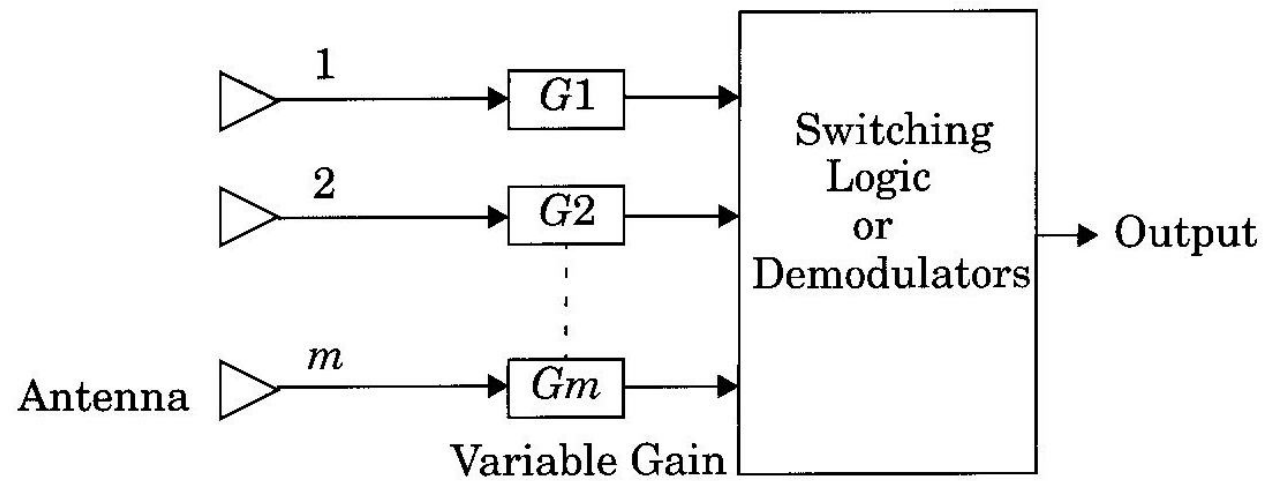

Figure 7.12 Generalized block diagram for space diversity.

2) Scanning Diversity

- scan each antenna until a signal is found that is above predetermined threshold
- if signal drops below threshold → rescan

– 0 | it a
ti

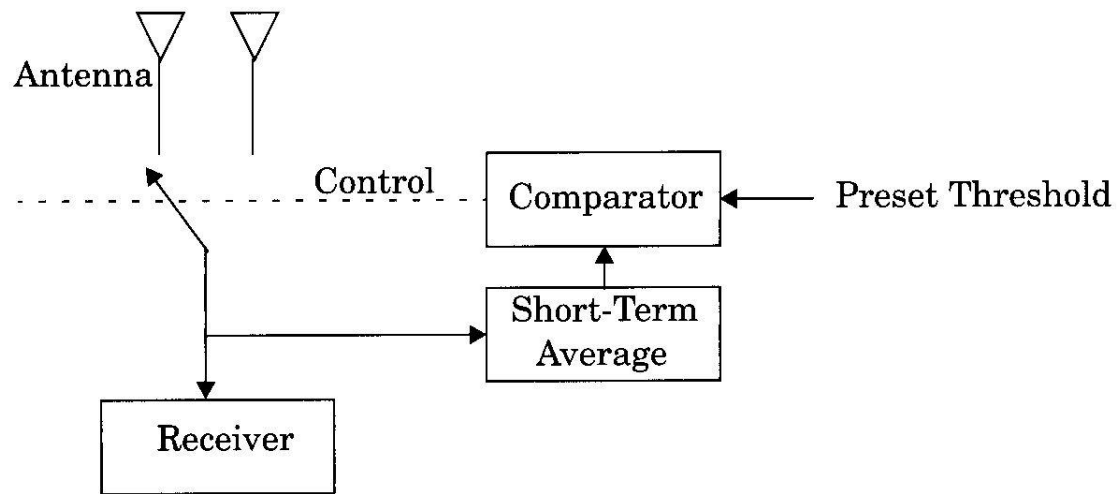

Figure 7.13 Basic form of scanning diversity.

3) Maximal Ratio Diversity

- signal amplitudes are weighted according to each *SNR*
- summed **in-phase**
- most complex of all types
- a complicated mechanism, but modern DSP makes this more practical → especially in the base station Rx where battery power to perform computations is not an issue

- The resulting signal envelop applied to detector:

$$r_M = \sum_{i=1}^M G_i r_i$$

- Total noise power:

$$N_T = N \sum_{i=1}^M G_i^2$$

- SNR applied to detector:

$$\gamma_M = \frac{r_M^2}{2N_T}$$

- The voltage signals γ_i from each of the M diversity branches are co-phased to provide coherent voltage addition and are individually weighted to provide optimal SNR

$$\gamma_M = \frac{1}{2} \frac{\sum (r_i^2 / N)^2}{N \sum (r_i^2 / N^2)} = \frac{1}{2} \sum_{i=1}^M \frac{r_i^2}{N} = \sum_{i=1}^M \gamma_i$$

(r_M s maximized when $G_i = r_i$)N

- The SNR out of the diversity combiner is the sum of the SNRs in each branch.

- The probability that γ_M less than some specific SNR threshold γ

$$p(\gamma_M) = \frac{\gamma_M^{M-1} e^{-\gamma_M/\Gamma}}{\Gamma^M (M-1)!} \quad \text{for } \gamma_M \geq 0$$

$$Pr\{\gamma_M \leq \gamma\} = \int_0^{\gamma} p(\gamma_M) d\gamma_M = 1 - e^{-\gamma/\Gamma} \sum_{k=1}^M \frac{(\gamma/\Gamma)^{k-1}}{(k-1)!}$$

– gives **optimal** *SNR* improvement :

- Γ_i : avg. *SNR* of each individual branch
- $\Gamma_i = \Gamma$ if the avg. *SNR* is the same for each branch

$$\overline{\gamma_M} = \sum_{i=1}^M \overline{\gamma_i} = \sum_{i=1}^M \Gamma_i = M\Gamma$$

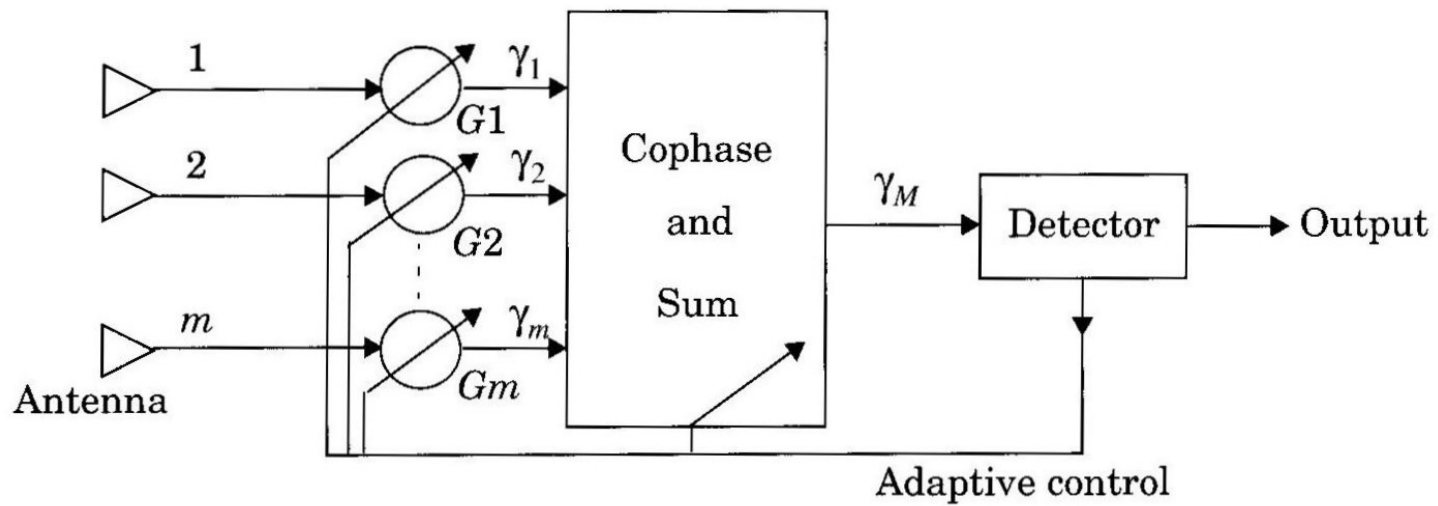

Figure 7.14 Maximal ratio combiner.

4) Equal Gain Diversity

- combine multiple signals into one
- $G = 1$, but the phase is adjusted for each received signal so that
 - The signal from each branch are co-phased
 - vectors add in-phase
- better performance than selection diversity

IV. Time Diversity

- Time Diversity → transmit repeatedly the information at different time spacings
 - Time spacing $>$ coherence time (coherence time is the time over which a fading signal can be considered to have similar characteristics)
 - So signals can be considered independent
 - Main disadvantage is that BW efficiency is significantly worsened – signal is transmitted more than once
 - BW must \uparrow to obtain the **same** R_d (data rate)

RAKE Receiver

- ❖ Powerful form of time diversity available in spread spectrum (DS) systems → CDMA
- ❖ Signal is only transmitted once
- ❖ Propagation delays in the MRC provide multiple copies of Tx signals delayed in time
- ❖ Attempts to collect the time-shifted versions of the original signal by providing a separate correlation receiver for each of the multipath signals.
- ❖ Each correlation receiver may be adjusted in time delay, so that a microprocessor controller can cause different correlation receivers to search in different time windows for significant multipath.
- ❖ The range of time delays that a particular correlator can search is called a search window.

- ❖ If time delay between multiple signals $>$ chip period of spreading sequence (T_c) \rightarrow multipath signals can be considered uncorrelated (independent)
 - In a basic system, these delayed signals only appear as noise, since they are delayed by more than a chip duration. And ignored.
 - Multiplying by the chip code results in noise because of the time shift.
 - But this can also be used to our advantage, by shifting the chip sequence to receive that delayed signal separately from the other signals.

- ❖ The RAKE Rx is a time diversity Rx that collects time-shifted versions of the original Tx signal

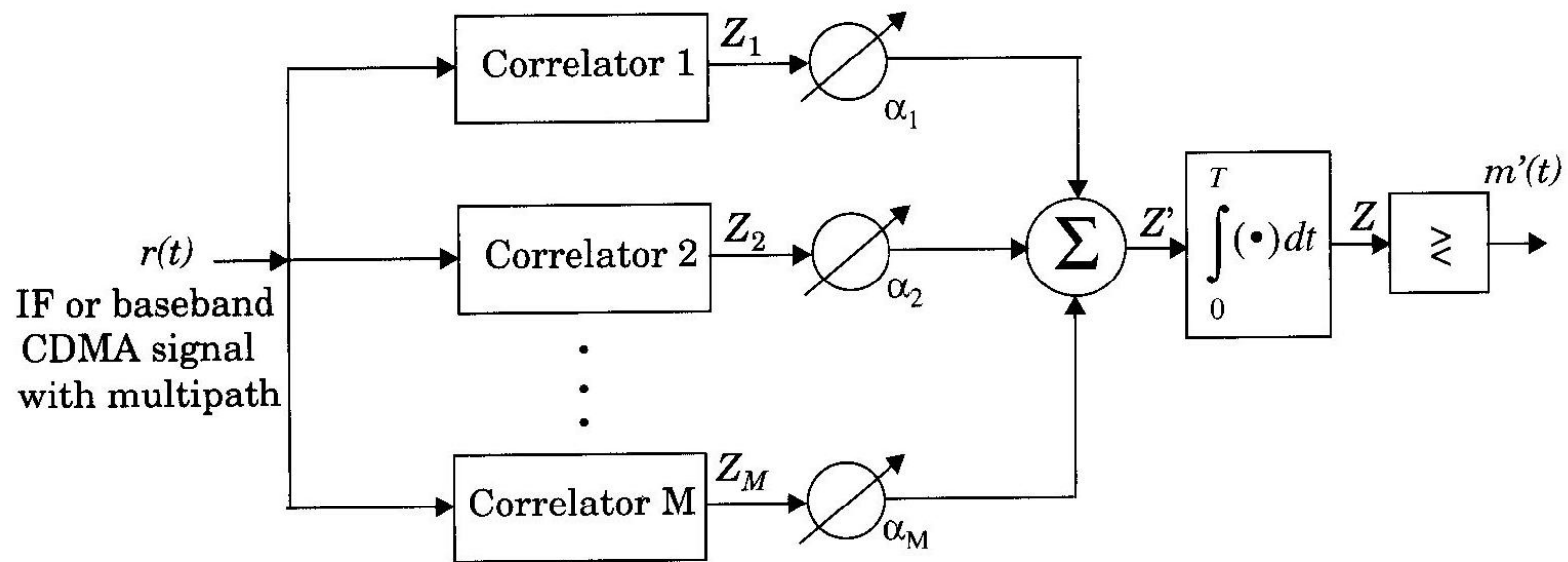

Figure 7.16 An M -branch (M -finger) RAKE receiver implementation. Each correlator detects a time shifted version of the original CDMA transmission, and each finger of the RAKE correlates to a portion of the signal which is delayed by at least one chip in time from the other fingers.

Cont.

- ❖ M branches or “fingers” = # of correlation Rx’s
- ❖ Separately detect the M strongest signals
- ❖ Weighted sum computed from M branches
 - Faded signal → low weight
 - Strong signal → high weight
 - Overcomes fading of a signal in a single branch

In indoor environments:

- ❖ The delay between multipath components is usually large, the low autocorrelation properties of a CDMA spreading sequence can assure that multipath components will appear nearly uncorrelated with each other.
- ❖ RAKE receiver in IS-95 CDMA has been found to perform poorly
 - Since the multipath delay spreads in indoor channels (≈ 100 ns) are much smaller than an IS-95 chip duration (≈ 800 ns).
 - In such cases, a rake will not work since multipath is unresolvable
 - Rayleigh flat-fading typically occurs within a single chip period.

Channel Coding :

- ❖ Error control coding ,detect, and often correct, symbols which are received in error
- ❖ The channel encoder separates or segments the incoming bit stream into equal length blocks of L binary digits and maps each L -bit message block into an N -bit code word where $N > L$

There are $M=2^L$ messages and 2^N code words of length N bits

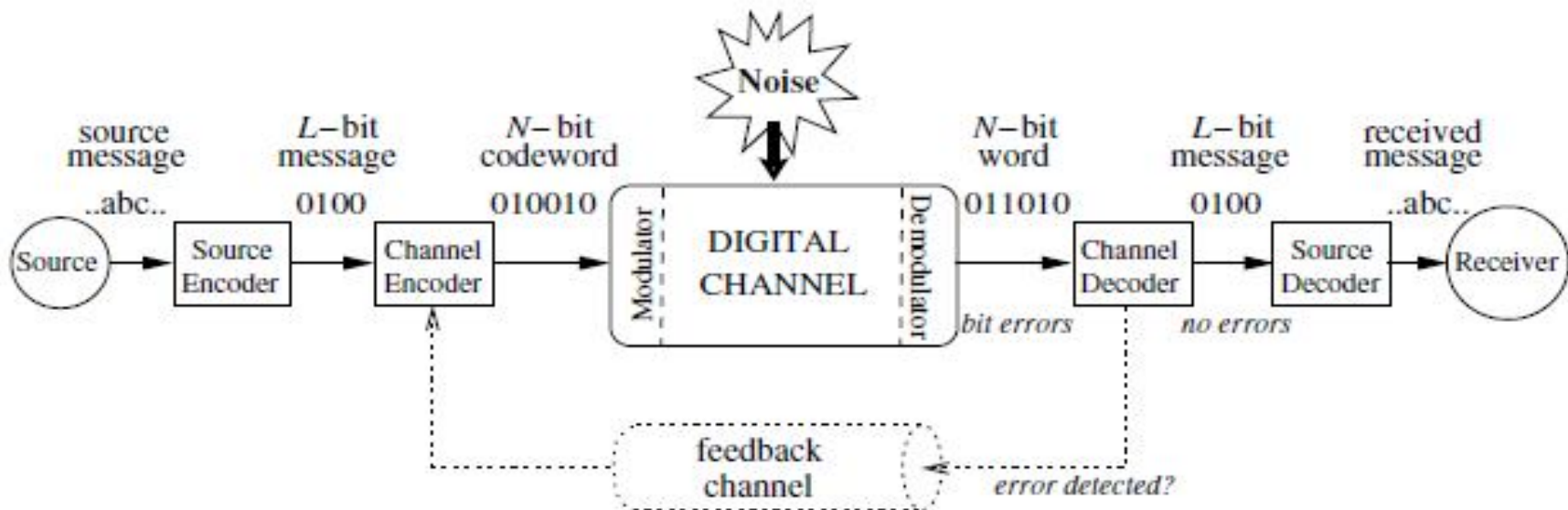

The channel decoder has the task of detecting that there has been a bit error and • (if possible) correcting the bit error

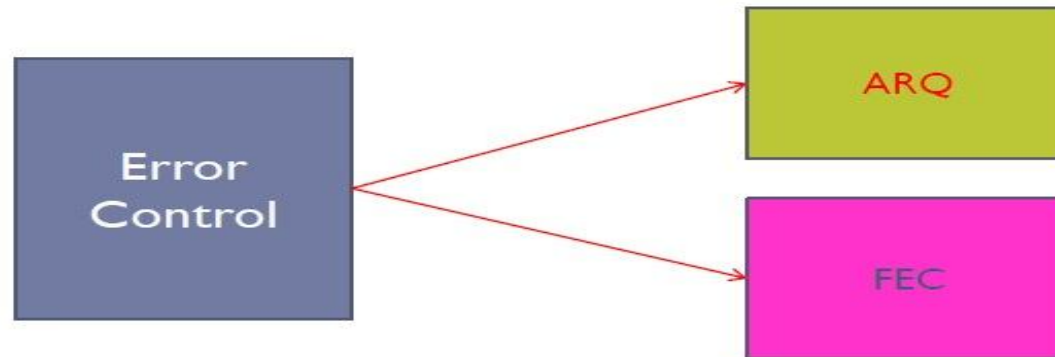

ARQ (Automatic-Repeat-Request) If the channel decoder performs error detection then errors can be detected and a feedback channel from the channel decoder to the channel encoder can be used to control the retransmission of the code word until the code word is received without detectable errors.

There are two major ARQ techniques stop and wait continuous ARQ

FEC (Forward Error Correction) If the channel decoder performs error correction then errors are not only detected but the bits in error can be identified and corrected (by bit inversion)

There are two major ARQ techniques.

- ❖ Stop and wait, in which each block of data is positively, or negatively, acknowledged by the receiving terminal as being error free before the next data block is transmitted,
- ❖ Continuous ARQ, in which blocks of data continue to be transmitted without waiting for each previous block to be acknowledged

Comanding for ‘narrow-band’ speech

- ❖ ‘Narrow-band’ speech is what we hear over telephones.
- ❖ Normally band-limited from 300 Hz to about 3500 Hz.
- ❖ May be sampled at 8 kHz.
- ❖ 8-bits per sample not sufficient for good ‘narrow-band’ speech encoding with uniform quantisation.
- ❖ Problem lies with setting a suitable quantisation step-size \square .
- ❖ One solution is to use instantaneous companding.
- ❖ Step-size adjusted according to amplitude of sample.
- ❖ For larger amplitudes, larger step-sizes used as illustrated next.
- ❖ ‘Instantaneous’ because step-size changes from sample to sample.

UNIT V

SYSTEM EXAMPLES AND DESIGN ISSUES

Multiple Access Techniques for Wireless Communication:

Many users can access the at same time, share a finite amount of radio spectrum with high performance duplexing generally required frequency domain time domain. They accessing techniques are,

- ❖ FDMA
- ❖ TDMA
- ❖ SDMA
- ❖ PDMA

Introduction

- ❖ many users at same time
- ❖ share a finite amount of radio spectrum
- ❖ high performance
- ❖ duplexing generally required
- ❖ frequency domain
- ❖ time domain

Frequency division duplexing (FDD)

- ❖ two bands of frequencies for every user
- ❖ forward band
- ❖ reverse band
- ❖ duplexer needed
- ❖ frequency separation between forward band and reverse band is constant

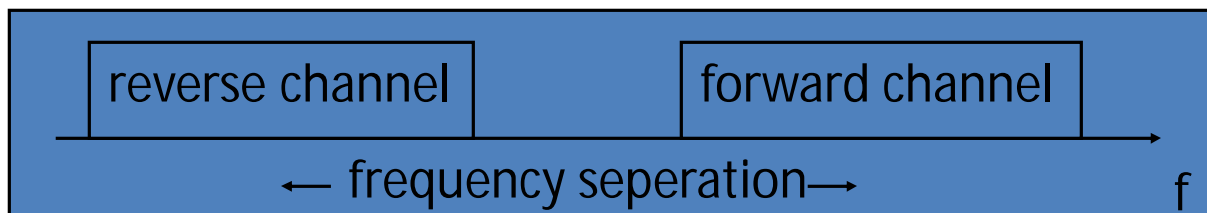

Time division duplexing (TDD)

- ❖ uses time for forward and reverse link
- ❖ multiple users share a single radio channel
- ❖ forward time slot
- ❖ reverse time slot
- ❖ no duplexer is required

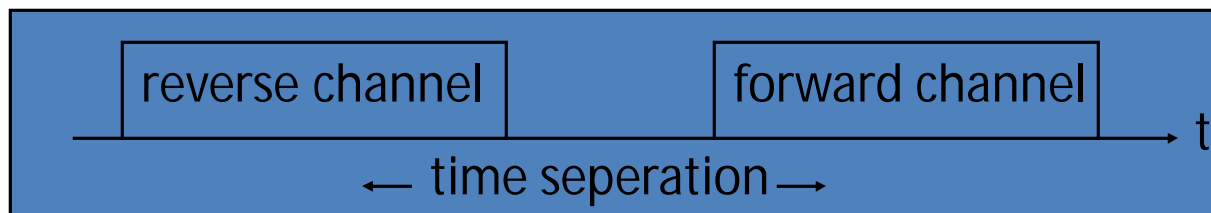

Multiple Access Techniques

- ❖ Frequency division multiple access (FDMA)
- ❖ Time division multiple access (TDMA)
- ❖ Code division multiple access (CDMA)
- ❖ Space division multiple access (SDMA)
- ❖ grouped as:
 - ❖ narrowband systems
 - ❖ wideband systems

Narrowband systems

- ❖ large number of narrowband channels
- ❖ usually FDD
- ❖ Narrowband FDMA
- ❖ Narrowband TDMA
- ❖ FDMA/FDD
- ❖ FDMA/TDD
- ❖ TDMA/FDD
- ❖ TDMA/TDD

Logical separation FDMA/FDD

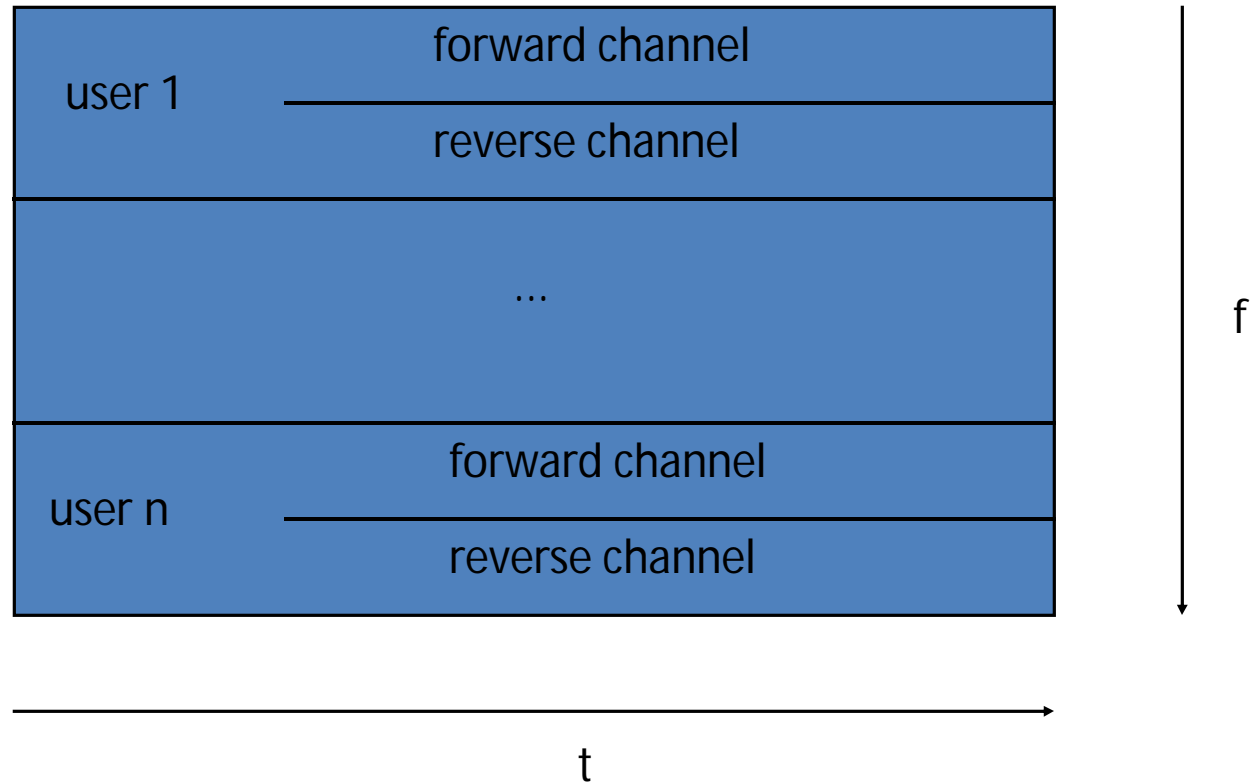

Logical separation FDMA/TDD

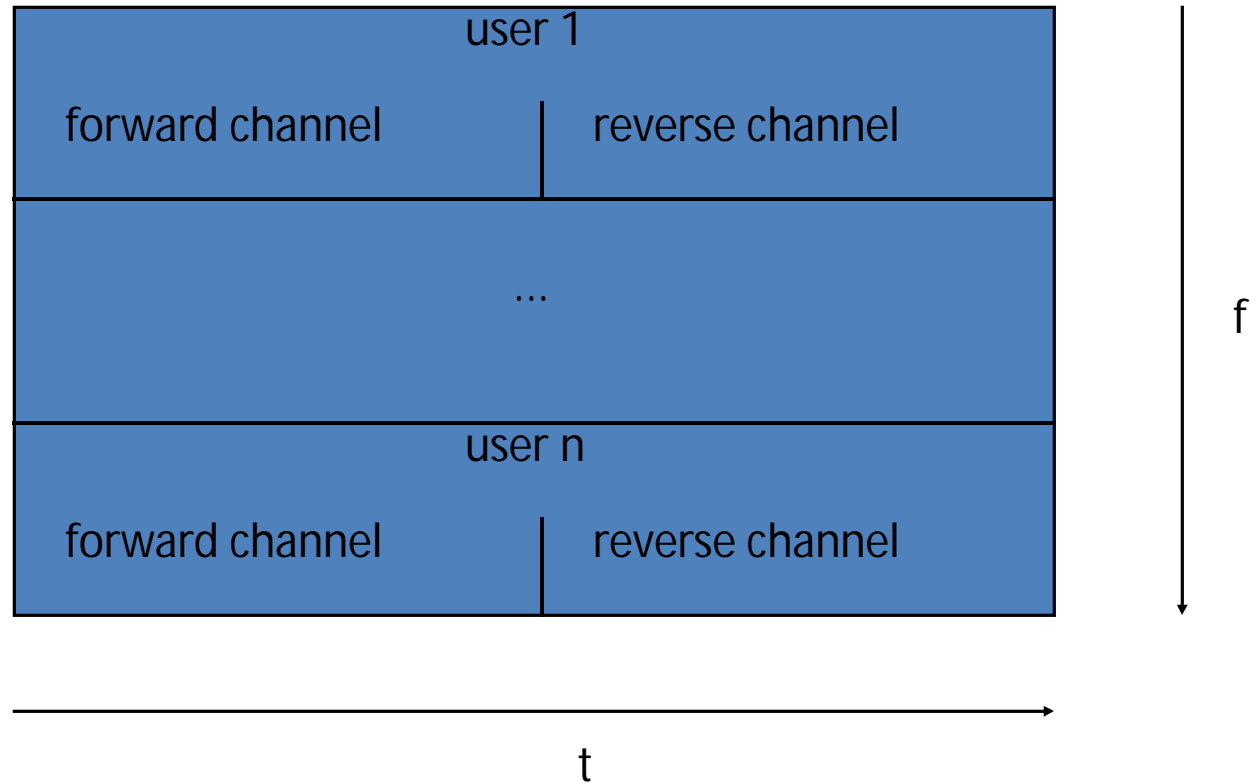

Logical separation TDMA/FDD

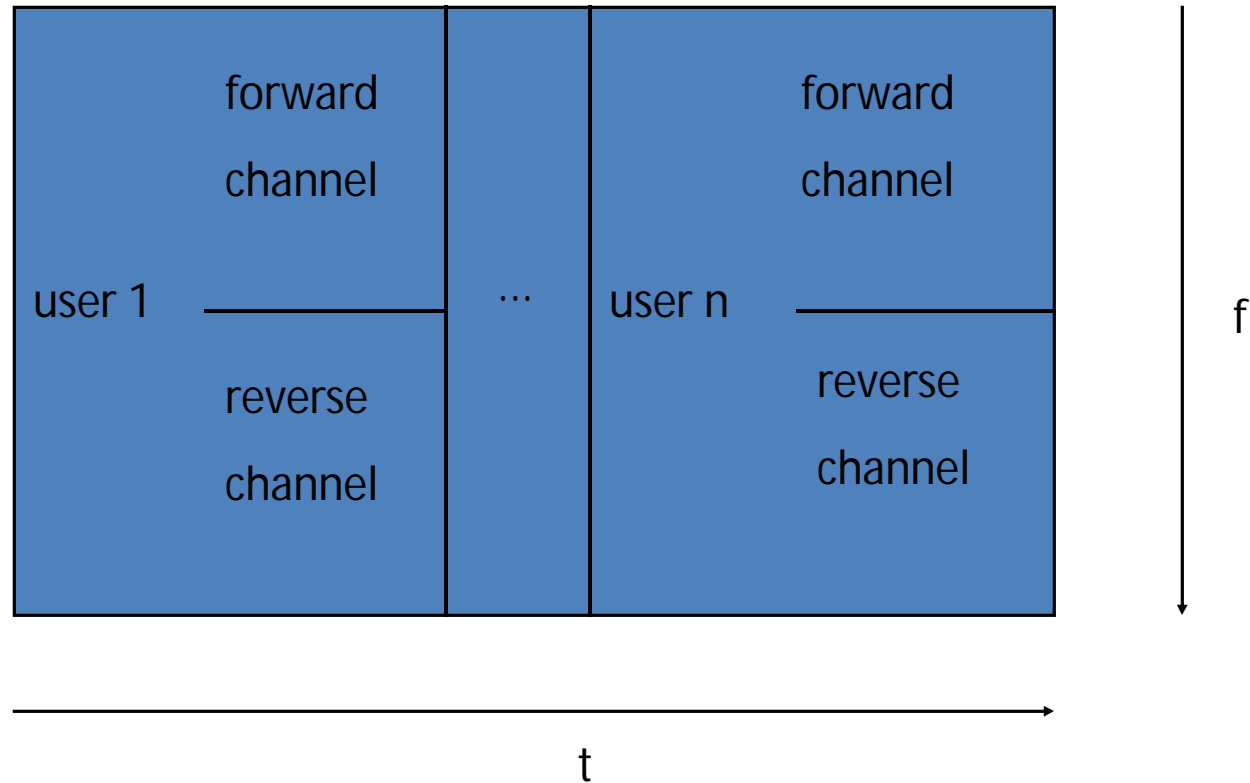

Logical separation TDMA/TDD

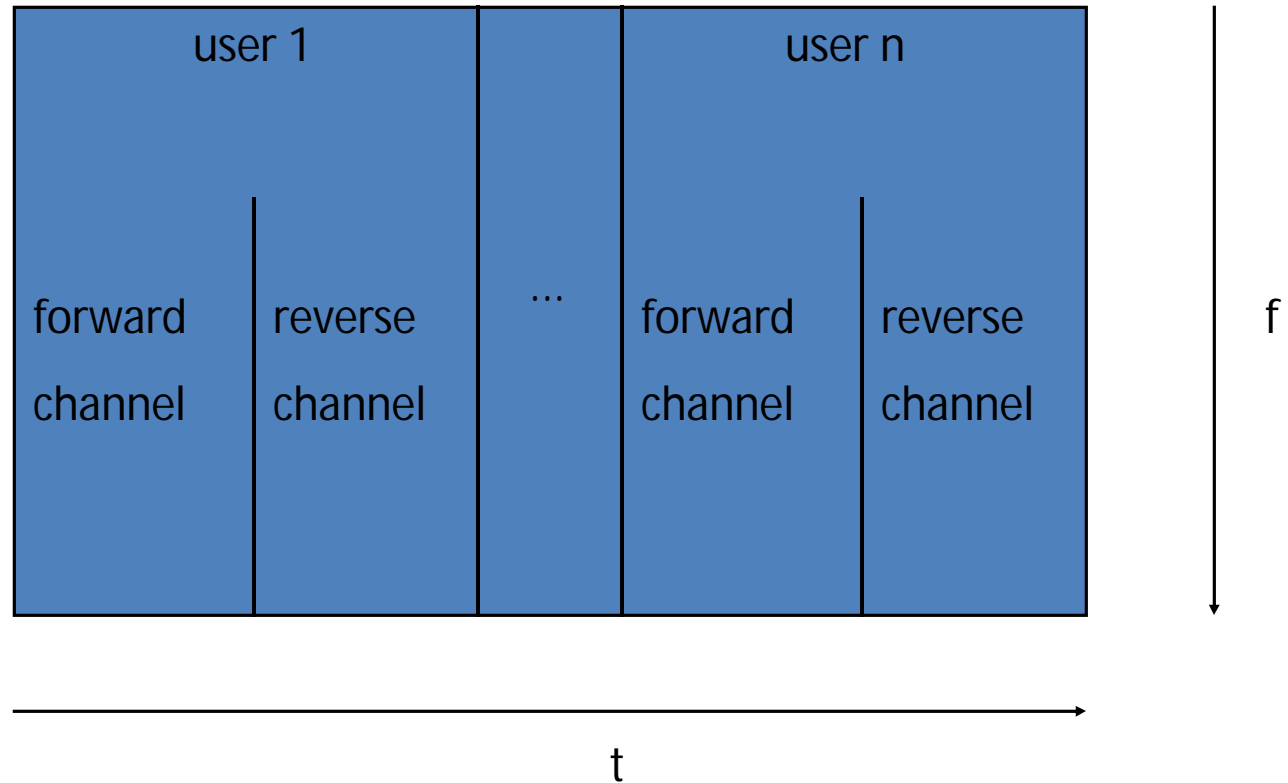

Wideband systems

- ❖ large number of transmitters on one channel
- ❖ TDMA techniques
- ❖ CDMA techniques
- ❖ FDD or TDD multiplexing techniques
- ❖ TDMA/FDD
- ❖ TDMA/TDD
- ❖ CDMA/FDD
- ❖ CDMA/TDD

Logical separation CDMA/FDD

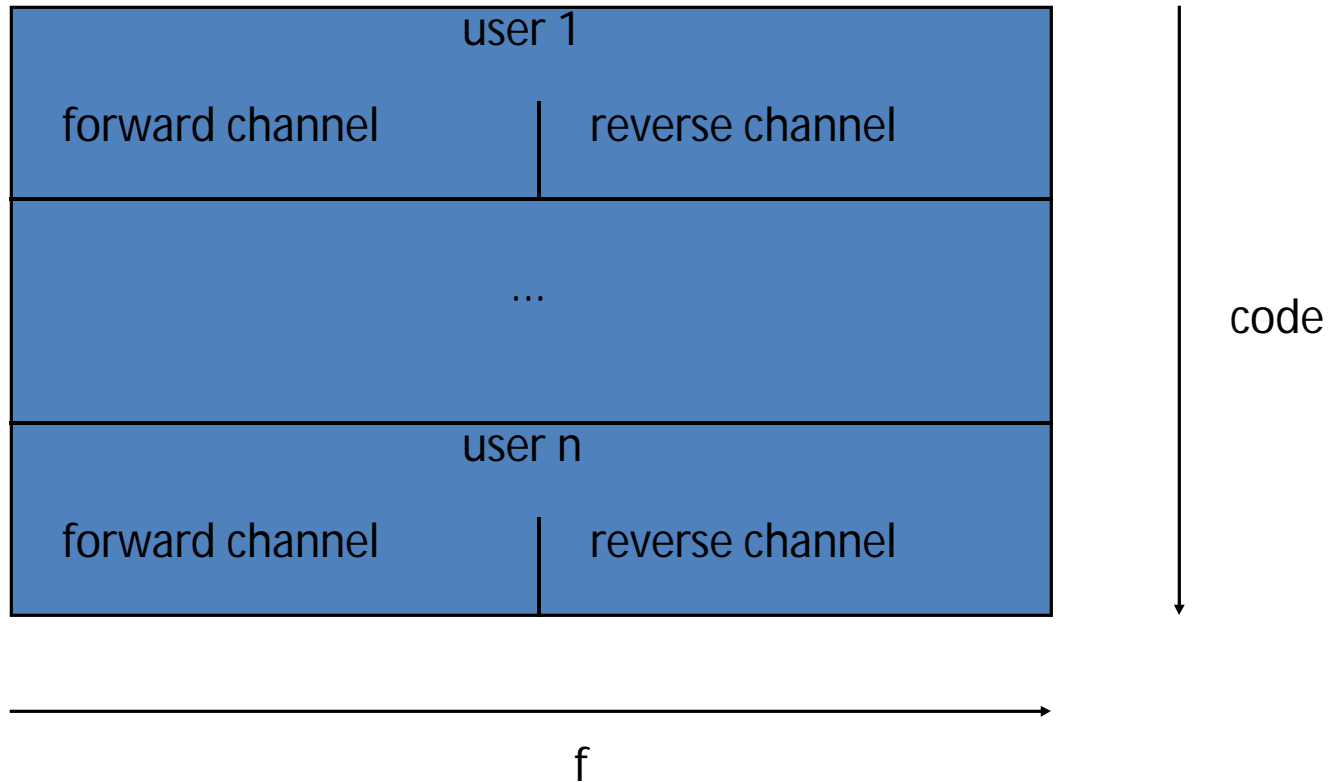

Logical separation CDMA/TDD

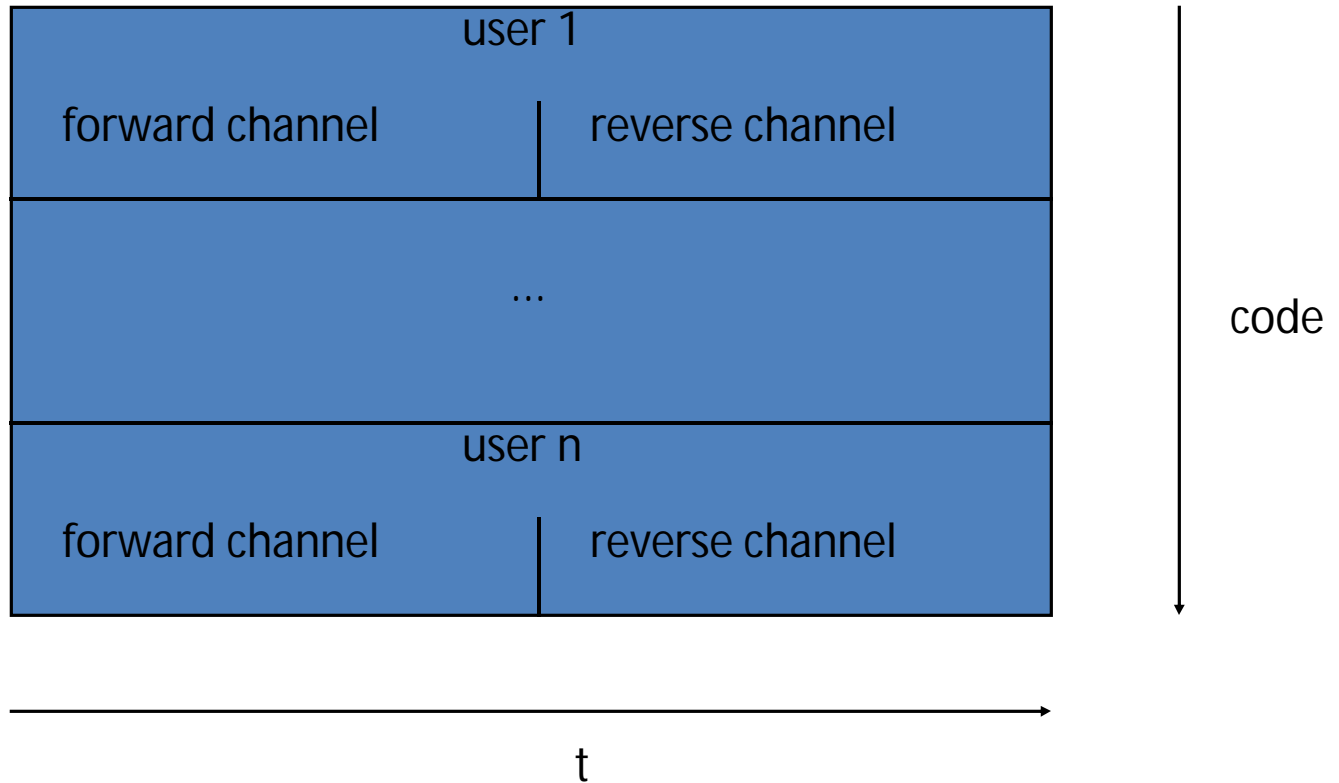

Multiple Access Techniques in use

Cellular System	Multiple Access Technique
Advanced Mobile Phone System (AMPS)	FDMA/FDD
Global System for Mobile (GSM)	TDMA/FDD
US Digital Cellular (USDC)	TDMA/FDD
Digital European Cordless Telephone (DECT)	FDMA/TDD
US Narrowband Spread Spectrum (IS-95)	CDMA/FDD

Frequency division multiple access FDMA

- ❖ One phone circuit per channel
- ❖ Idle time causes wasting of resources
- ❖ Simultaneously and continuously transmitting
- ❖ Usually implemented in narrowband systems
- ❖ For example: in AMPS is a FDMA bandwidth of 30 kHz implemented

FDMA compared to TDMA

- ❖ Fewer bits for synchronization
- ❖ Fewer bits for framing
- ❖ Higher cell site system costs
- ❖ Higher costs for duplexer used in base station and subscriber units
- ❖ FDMA requires RF filtering to minimize adjacent **channel interference**

Nonlinear Effects in FDMA

- ❖ Many channels - same antenna
- ❖ For maximum power efficiency operate near saturation
- ❖ Near saturation power amplifiers are nonlinear
- ❖ Nonlinearities causes signal spreading
- ❖ Intermodulation frequencies

Nonlinear Effects in FDMA

- ❖ IM are undesired harmonics
- ❖ Interference with other channels in the FDMA system
- ❖ Decreases user C/I - decreases performance
- ❖ Interference outside the mobile radio band: adjacent-channel interference
- ❖ RF filters needed - higher costs

Number of channels in a FDMA system

$$N = \frac{B_t - B_{\text{guard}}}{B_c}$$

- ❖ N ... number of channels
- ❖ B_t ... total spectrum allocation
- ❖ B_{guard} ... guard band
- ❖ B_c ... channel bandwidth

Time Division Multiple Access

- ❖ Time slots
- ❖ One user per slot
- ❖ Buffer and burst method
- ❖ Noncontinuous transmission
- ❖ Digital data
- ❖ Digital modulation

Repeating Frame Structure

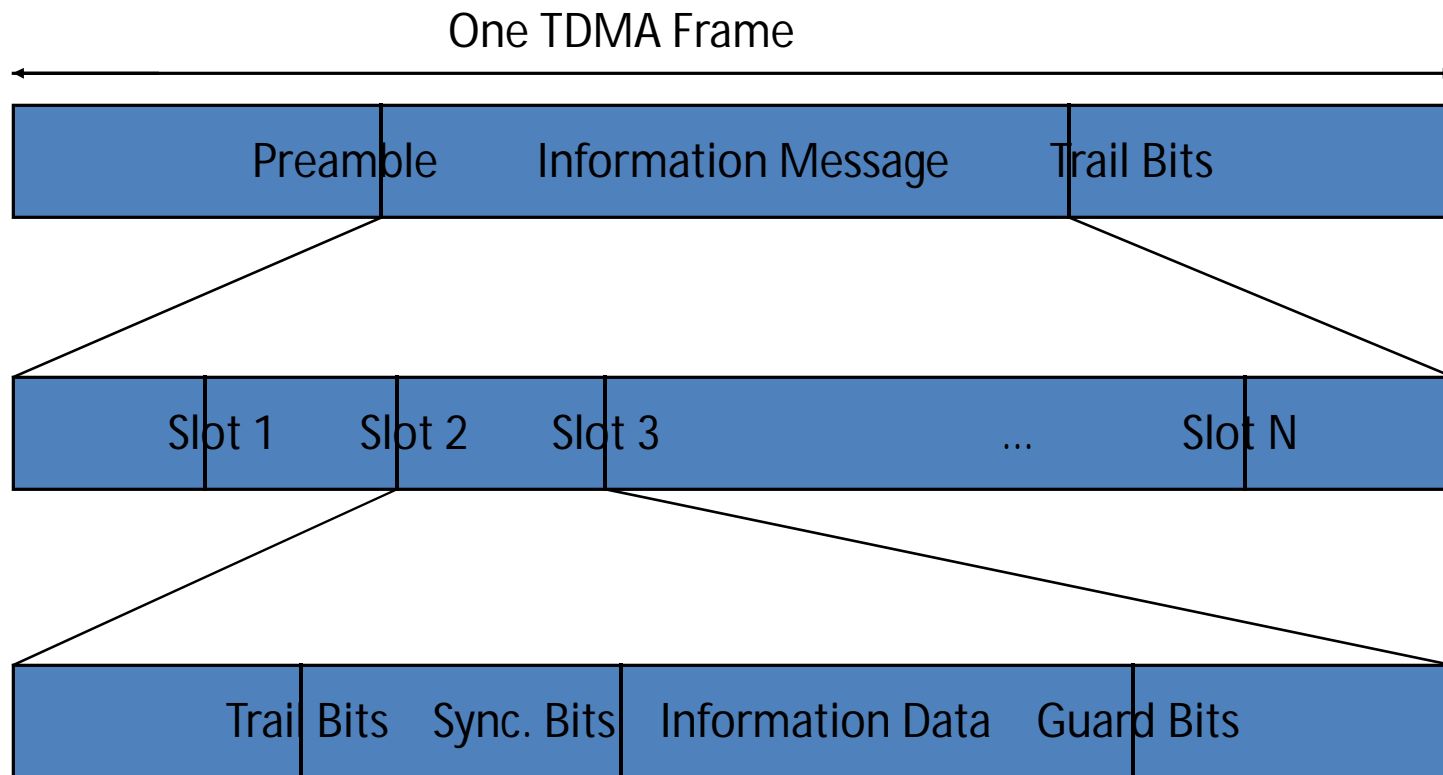

The frame is cyclically repeated over time.

Features of TDMA

- ❖ A single carrier frequency for several users
- ❖ Transmission in bursts
- ❖ Low battery consumption
- ❖ Handoff process much simpler
- ❖ FDD : switch instead of duplexer
- ❖ Very high transmission rate
- ❖ High synchronization overhead
- ❖ Guard slots necessary

Number of channels in a TDMA system

$$N = \frac{m * (B_{tot} - 2 * B_{guard})}{B_c}$$

- ❖ N ... number of channels
- ❖ m ... number of TDMA users per radio channel
- ❖ B_{tot} ... total spectrum allocation
- ❖ B_{guard} ... Guard Band
- ❖ B_c ... channel bandwidth

Example: Global System for Mobile (GSM)

- ❖ TDMA/FDD
- ❖ forward link at $B_{\text{tot}} = 25 \text{ MHz}$
- ❖ radio channels of $B_c = 200 \text{ kHz}$
- ❖ if $m = 8$ speech channels supported, and
- ❖ if no guard band is assumed :

$$N = \frac{8 * 25E6}{200E3} = 1000 \text{ simultaneous users}$$

Efficiency of TDMA

- ❖ Percentage of transmitted data that contain information
- ❖ Frame efficiency η_f
- ❖ Usually end user efficiency $< \eta_f$,
- ❖ Because of source and channel coding

Repeating Frame Structure

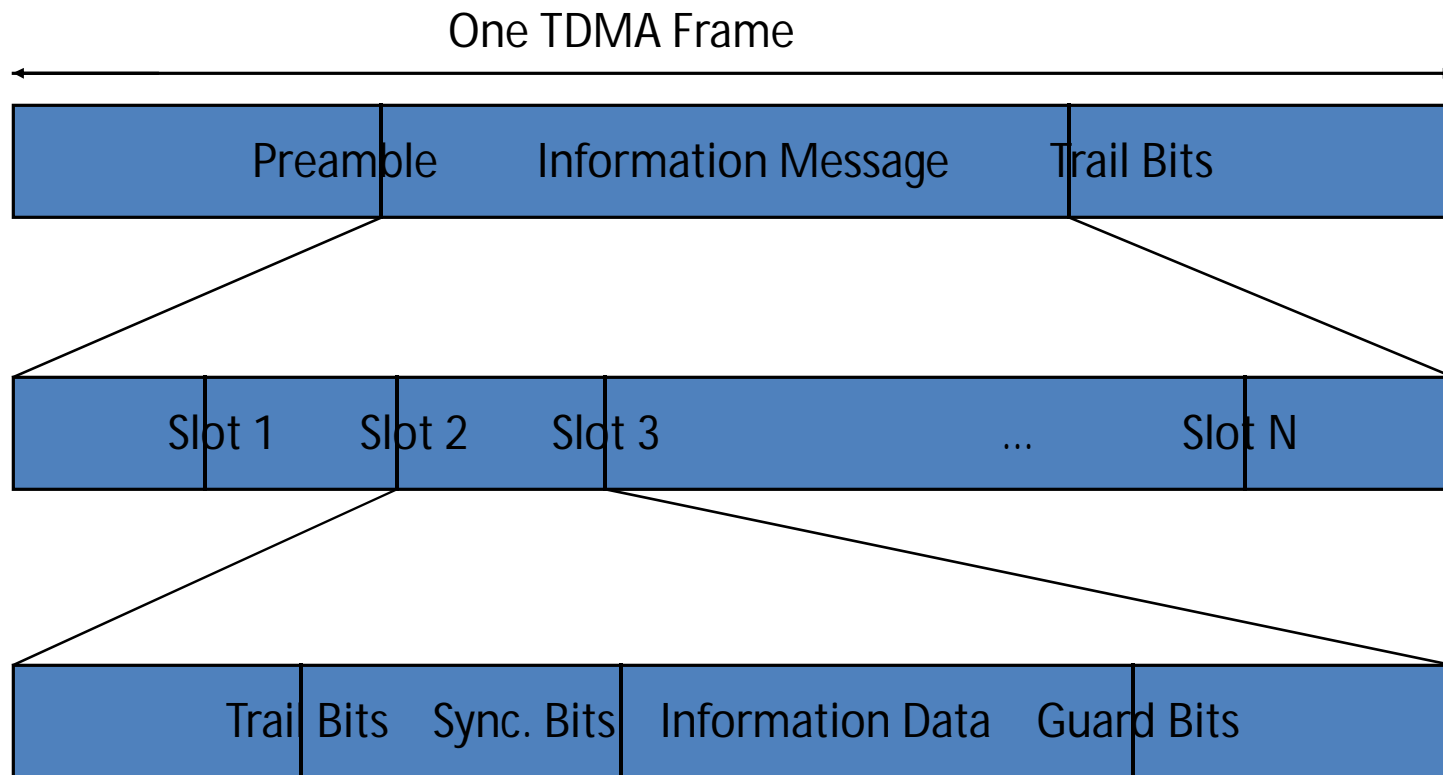

The frame is cyclically repeated over time.

Efficiency of TDMA

$$b_{OH} = N_r * b_r + N_t * b_p + N_t * b_g + N_r * b_g$$

- ❖ b_{OH} ... number of overhead bits
- ❖ N_r ... number of reference bursts per frame
- ❖ b_r ... reference bits per reference burst
- ❖ N_t ... number of traffic bursts per frame
- ❖ b_p ... overhead bits per preamble in each slot
- ❖ b_g ... equivalent bits in each guard time intervall

Efficiency of TDMA

$$b_T = T_f * R$$

- ❖ b_T ... total number of bits per frame
- ❖ T_f ... frame duration
- ❖ R ... channel bit rate

Efficiency of TDMA

$$\eta_f = (1 - b_{OH}/b_T) * 100\%$$

- ❖ η_f ... frame efficiency
- ❖ b_{OH} ... number of overhead bits per frame
- ❖ b_T ... total number of bits per frame

Space Division Multiple Access

- ❖ Controls radiated energy for each user in space
- ❖ using spot beam antennas
- ❖ base station tracks user when moving
- ❖ cover areas with same frequency:
 - ❖ TDMA or CDMA systems
 - ❖ cover areas with same frequency:
 - ❖ FDMA systems

Space Division Multiple Access

❖ primitive applications are “Sectorized antennas”

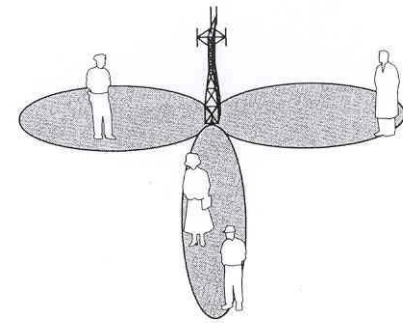

❖ In future adaptive antennas simultaneously steer energy in the direction of many users at once

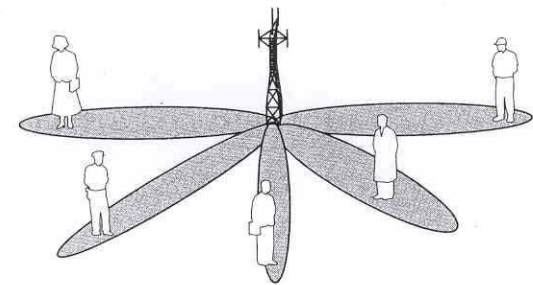

Reverse link problems

- ❖ General problem
- ❖ Different propagation path from user to base
- ❖ Dynamic control of transmitting power from each user to the base station required
- ❖ Limits by battery consumption of subscriber units
- ❖ Possible solution is a filter for each user

Solution by SDMA systems

- ❖ Adaptive antennas promise to mitigate reverse link problems
- ❖ Limiting case of infinitesimal beamwidth
- ❖ Limiting case of infinitely fast track ability
- ❖ Thereby unique channel that is free from interference
- ❖ All user communicate at same time using the same channel

Disadvantage of SDMA

- ❖ Perfect adaptive antenna system: infinitely large antenna needed
- ❖ Compromise needed

SDMA and PDMA in satellites

- ❖ INTELSAT IVA
- ❖ SDMA dual-beam receive antenna
- ❖ Simultaneously access from two different regions of the earth

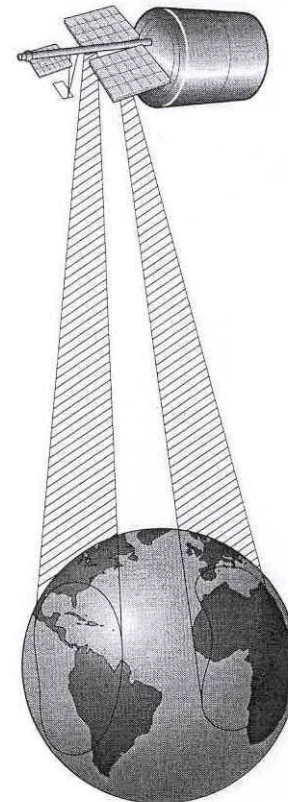

SDMA and PDMA in satellites

- COMSTAR 1
- PDMA
- separate antennas
- simultaneously access from same region

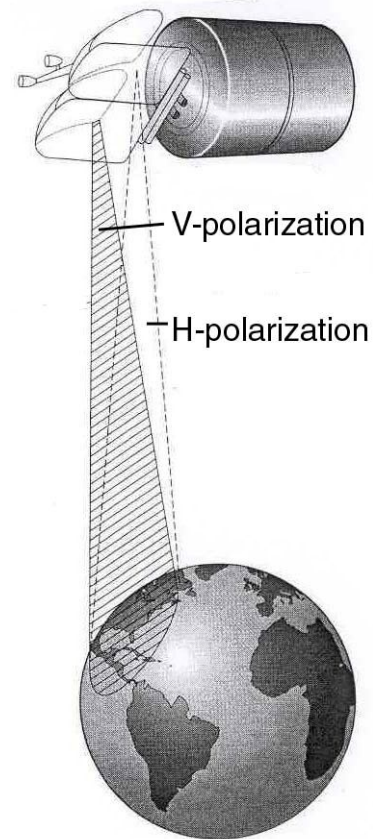

SDMA and PDMA in satellites

- ❖ INTELSAT V
- ❖ PDMA and SDMA
- ❖ Two hemispheric coverage by SDMA
- ❖ Two smaller beam zones by PDMA
- ❖ Orthogonal polarization

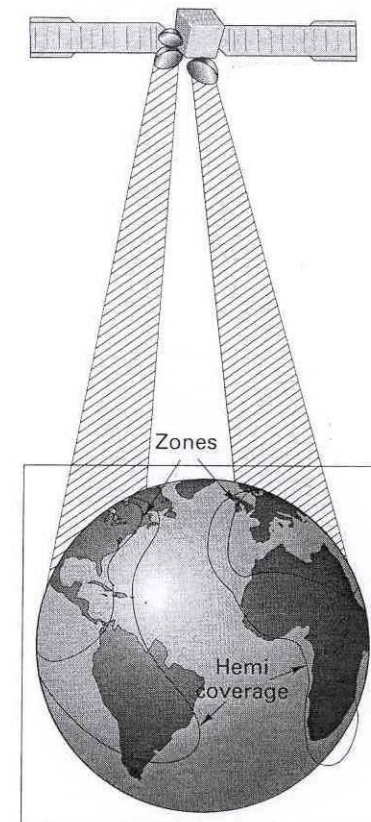

Capacity of Cellular Systems

- ❖ Channel capacity: maximum number of users in a fixed frequency band
- ❖ Radio capacity : value for spectrum efficiency
- ❖ Reverse channel interference
- ❖ Forward channel interference
- ❖ How determine the radio capacity?

Co-Channel Reuse Ratio Q

$$Q = D/R$$

- ❖ Q ... co-channel reuse ratio
- ❖ D ... distance between two co-channel cells
- ❖ R ... cell radius

Forward channel interference

- ❖ cluster size of 4
- ❖ D_0 ... distance serving station to user
- ❖ D_K ... distance co-channel base station to user

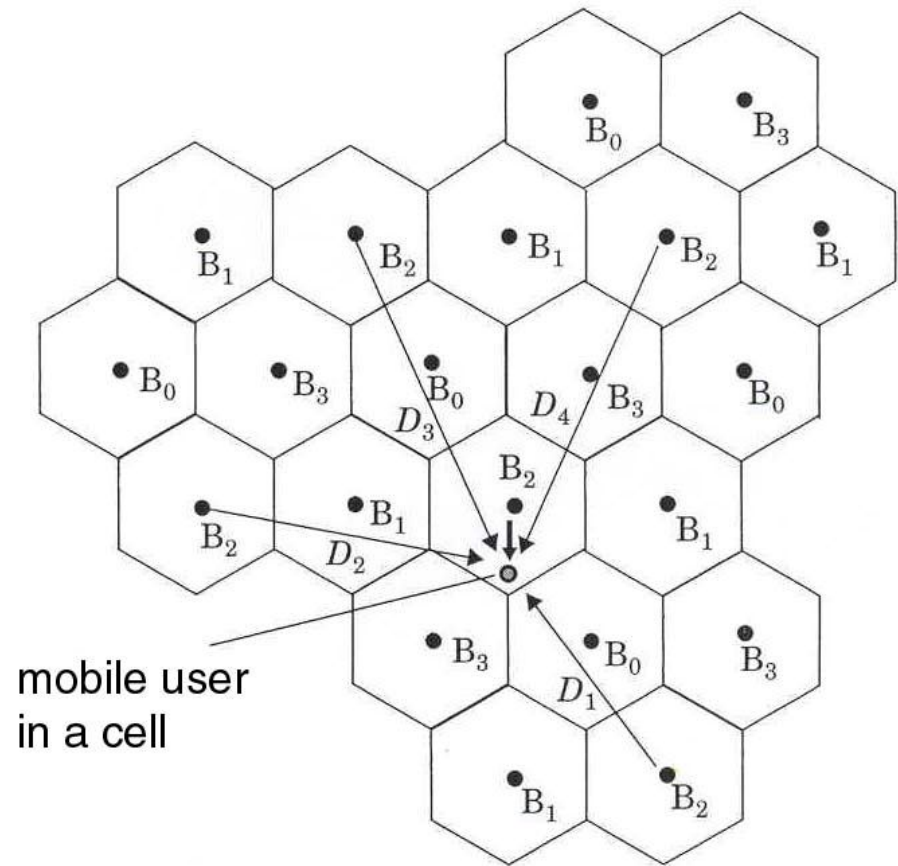

Cellular Wireless Network Evolution

- **First Generation: Analog**
 - AMPS: Advance Mobile Phone Systems
 - Residential cordless phones
- **Second Generation: Digital**
 - IS-54: North American Standard - TDMA
 - IS-95: CDMA (Qualcomm)
 - GSM: Pan-European Digital Cellular
 - DECT: Digital European Cordless Telephone

Cellular Evolution (cont)

- **Third Generation: T/CDMA**

- combines the functions of: cellular, cordless, wireless LANs, paging etc.
- supports multimedia services (data, voice, video, image)
- a progression of integrated, high performance systems:
 - (a) GPRS (for GSM)**
 - (b) EDGE (for GSM)**
 - (c) 1xRTT (for CDMA)**
 - (d) UMTS**

Cellular systems around the world

- US systems (cont'd)

- **PCS1900:** Personal Communications System, 1900 MHz band
Based on GSM and DCS1800

- **CDMA2000:**

Third-generation, digital system
Evolution of IS-95

- **General:** Dual-mode terminals AMPS/xxxx
Network protocol IS-41
Only AMPS national coverage, rest local

Advance Mobile Phone System

Invented by Bell Labs; installed
In US in 1982; in Europe as TACS

Architecture

- 7/21 site/sector reuse
- 18 dB C/I
- Mobile Identity Number (MIN)
- Electronic Serial Number (ESN)
- Network protocol IS-41

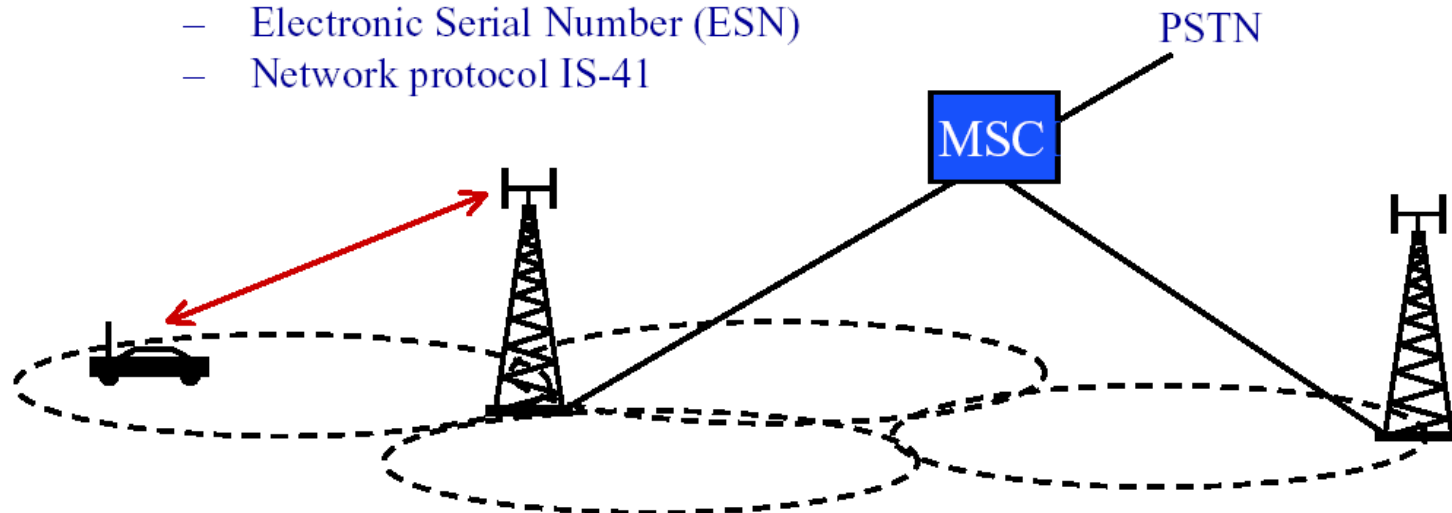

AMPS (Advance Mobile Phone System):

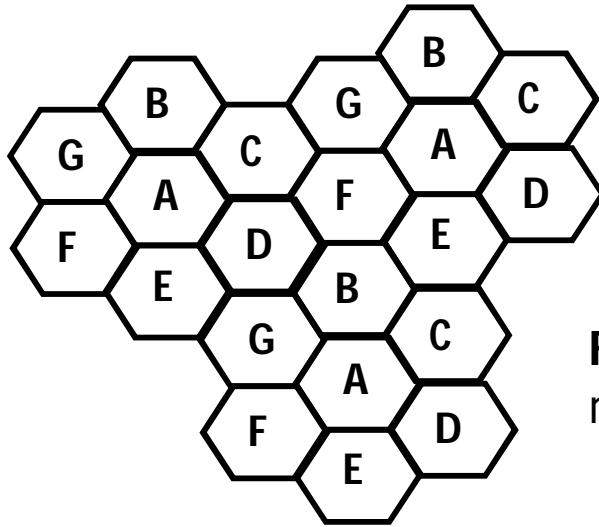

FDMA (Frequency Div Multiple Access): one frequency per user channel

Frequency Reuse: Frequencies are not reused in a group of 7 adjacent cells

In each cell, 57 channels each for A-side and B -side carrier respectively; about 800 channels total (across the entire AMPS system)

Advanced Mobile Phone System

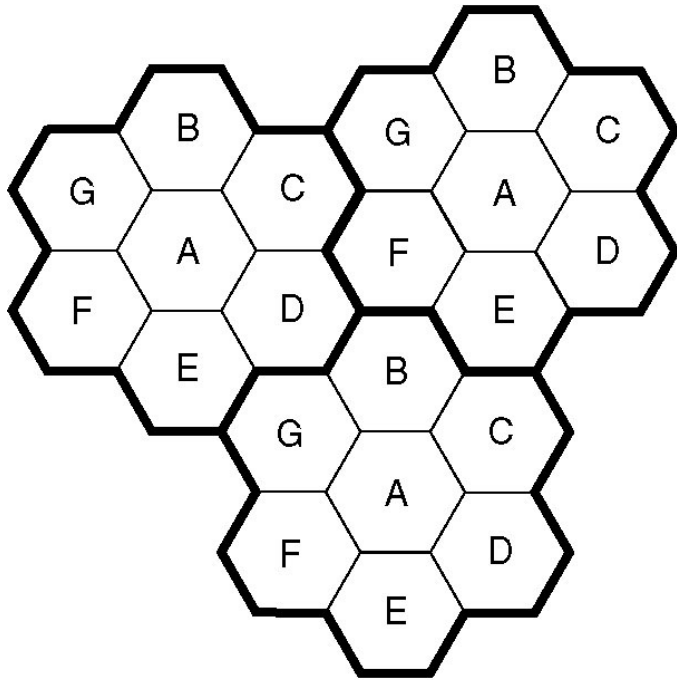

(a)

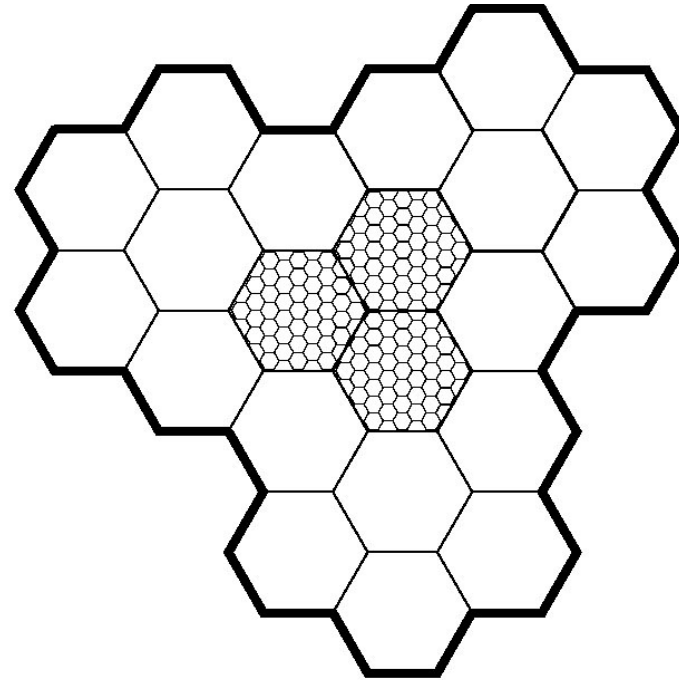

(b)

- (a) Frequencies are not reused in adjacent cells.
- (b) To add more users, smaller cells can be used.

Channel Categories

The channels are divided into four categories:

- **Control** (base to mobile) to manage the system
- **Paging** (base to mobile) to alert users to calls for them
- **Access** (bidirectional) for call setup and channel assignment
- **Data** (bidirectional) for voice, fax, or data

Handoff

- **Handoff:** Transfer of a mobile from one cell to another
- Each base station constantly monitors the received power from each mobile.
- When power drops below given threshold, base station asks neighbor station (with stronger received power) to pick up the mobile, on a new channel.
- In APMS the handoff process takes about 300 msec.
- **Hard handoff:** user must switch from one frequency to another (noticeable disruption)
- **Soft Handoff** (available only with CDMA): no change in frequency.

To register and make a phone call

- When phone is switched on , it scans a preprogrammed list of 21 **control** channels, to find the most powerful signal.
- It transmits its ID number on it to the MSC – which informs the home MSC (registration is done every 15 min)
- To make a call, user transmits dest Ph # on random **access** channel; MSC will assign a **data** channel
- At the same time MSC **pages** the destination cell for the other party (idle phone **listens** on all page channels)

AMPS: physical layer

Radio bands

- 832 duplex (paired) channels
- A/B separation: 416 channels each
- channel spacing 30 kHz

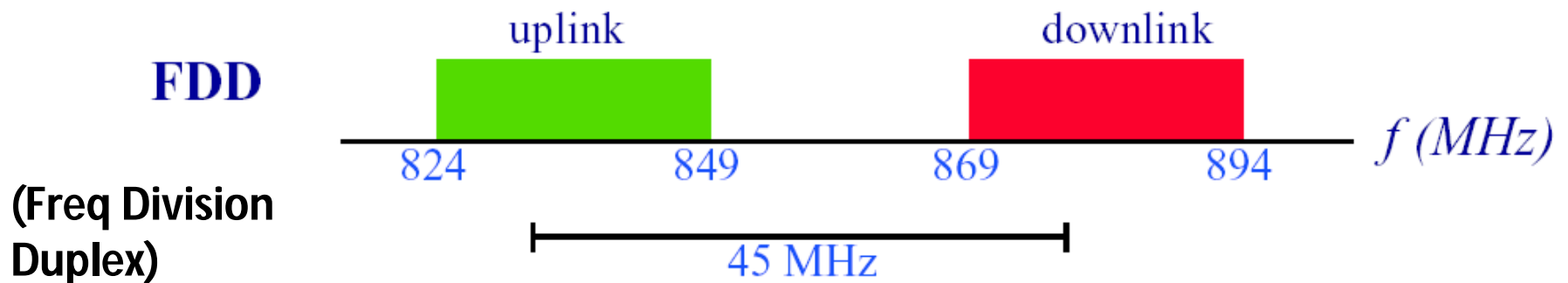

AMPS: physical layer

Modulation

- traffic (voice): analog FM
peak deviation $\Delta f = \pm 12$ kHz
companding / expanding
pre-emphasis / de-emphasis
 - control (data): binary FSK (“0” \rightarrow -8 kHz, “1” \rightarrow +8 kHz)
10 kb/s data rate
Manchester NRZ coding
BCH(40,28) downlink, BCH(48,36) uplink
blank-and-burst
 - Supervisory Audio Tone (SAT)
5970 / 6000 / 6030 tone
co-channel separation
-

Digital Cellular: IS-54 TDMA System

- Second generation: **digital** (as opposed to analog as in AMPS)
- Same frequency as AMPS
- Each 30 kHz RF channel is used at a rate of 48.6 kbps
 - 6 TDM slots/RF band (2 slots per user)
 - 8 kbps voice coding
 - 16.2 kbps TDM digital channel (3 channels fit in 30kHz)
- 4 cell frequency reuse (instead of 7 as in AMPS)
- Capacity increase per cell per carrier
 - $3 \times 416 / 4 = 312$ (instead of 57 in AMPS)
 - Additional factor of two with speech activity detection.

US Digital Cellular

- **Standard: USDC = D-AMPS = IS-54 = IS-136 (EIA/TIA)**
- **TDMA/AMPS dual-mode terminals**
- **Split each AMPS FDMA channel into six TDMA channels**
- **Reuse of AMPS analog control channels: IS-54**
- **New digital control channels: IS-136**



USDC: architecture

- 7/21 site/sector reuse
- 18 dB C/I
- Mobile Identity Number (MIN)
- Electronic Serial Number (ESN)
- Network protocol IS-41

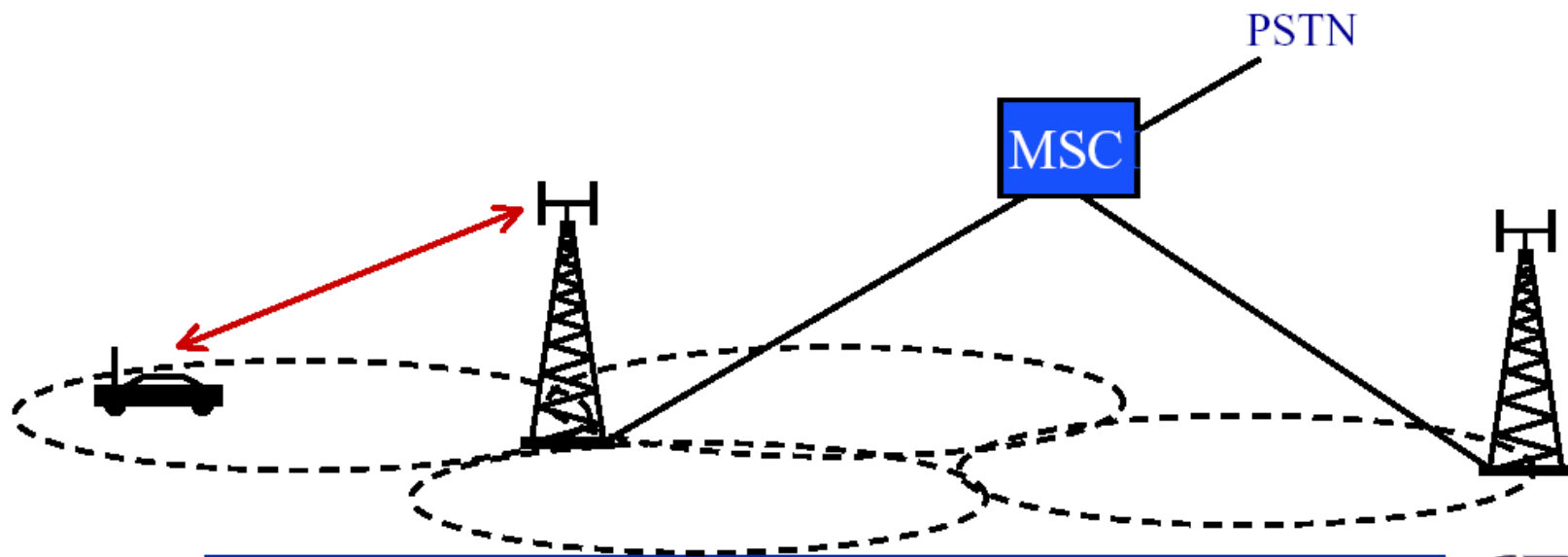

GSM (Group Speciale Mobile)

Pan European Cellular Standard

Second Generation: **Digital**

Frequency Division Duplex (890-915 MHz Upstream; 935-960 MHz Downstream)

125 frequency carriers

Carrier spacing: 200 Khz

8 channels per carrier (Narrowband Time Division)

Speech coder: linear predictive coding (Source rate = 13 Kbps)

Modulation: phase shift keying (Gaussian minimum shift keying)

Slow frequency hopping to overcome multipath fading

GSM

- **Groupe Spéciale Mobile**
- **Standard: GSM - DSC1800 - PCS1900 (ETSI)**
- **Pan-European system**

GSM: architecture

- 3/9 site/sector reuse
- 11 dB C/I
- International Mobile Subscriber Number (IMSI/TMSI)
- International Mobile Equipment Identity (IMEI)
- ISDN-based network

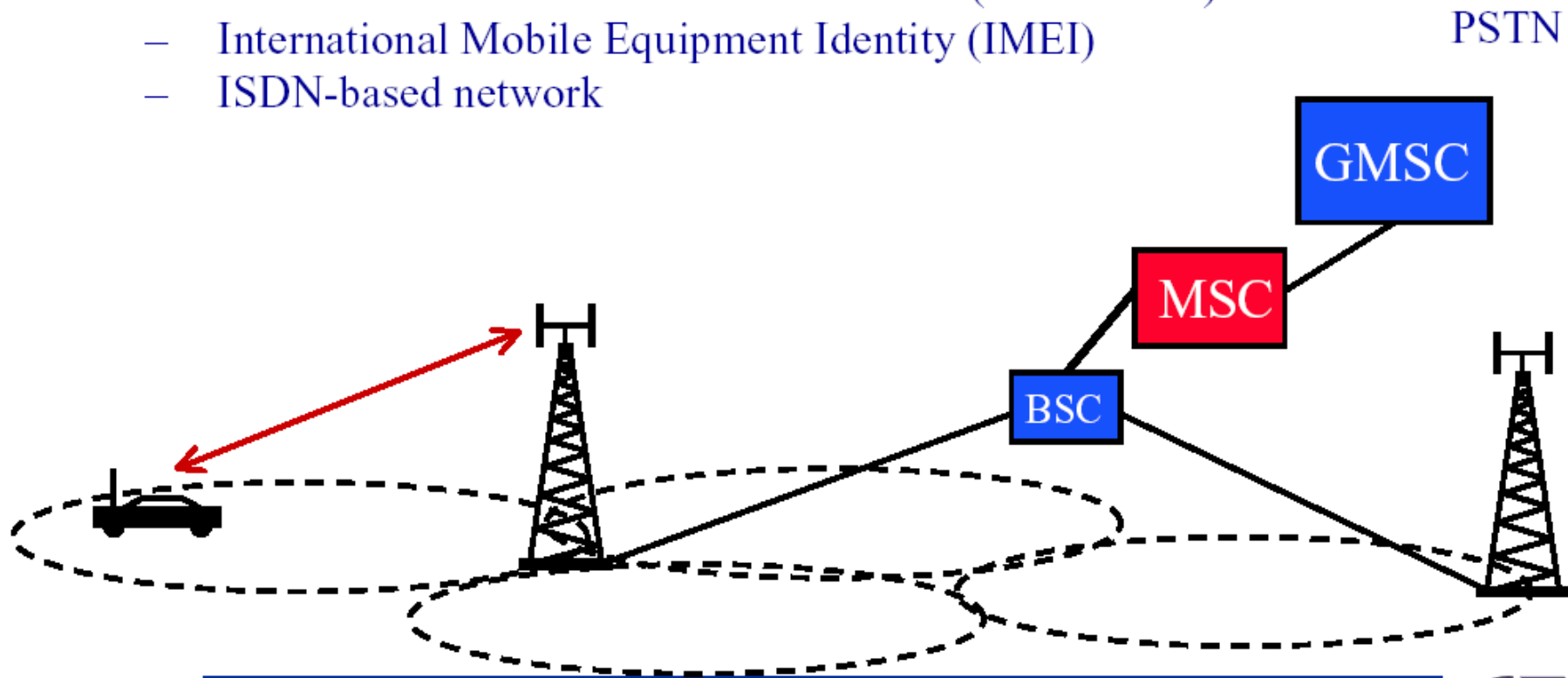

IS-95

- **Interim Standard 95; (TIA)**
- **CDMA/AMPS dual-mode terminals**
- **Narrowband CMDA (BW \approx 1.25 MHz)**
- **Qualcomm (1994)**

IS-95: architecture

- 1/1 reuse
- Mobile Identity Number (MIN)
- Electronic Serial Number (ESN)
- Network protocol IS-41

